



DELTA CO GAMING



DELTA CO

RGB GAMING CHAIR 332 LED MODES

BUL Благодарим Ви,
че избрахте Deltaco!

DAN Brugermanual

DEU Benutzerhandbuch1

ENG User manual

EST Kasutusjuhend

FIN Käyttöopas

FRA Manuel d'utilisation

HUN Felhasználói kézikönyv

LAV Lietošanas pamācība

LIT Naudojimo instrukcija

NLD Gebruiksaanwijzing











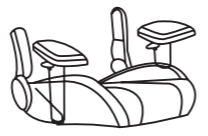
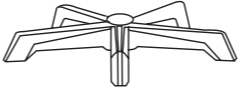

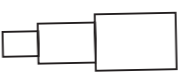
NOR Brukermanual

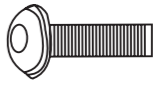
POL Instrukcja obsługi

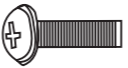
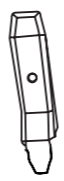
SPA Manual del usuario

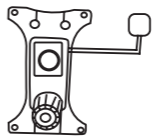
SWE Användarmanual

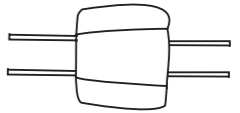
BUL Благодарим Ви, че избрахте Deltaco!
DAN Tak fordi du har valgt Deltaco!
DEU Vielen Dank, dass Sie sich für Deltaco entschieden haben!
ENG Thank you for choosing Deltaco!
EST Täname teid Deltaco valimise eest!
FIN Kiitos, kun valitsit Deltaco-tuotteen!
FRA Merci de choisir Deltaco !
HUN Köszönjük, hogy a Deltaco-t választotta!
LAV Paldies, ka izvēlējāties Deltaco!
LIT Ačiū, kad renkatės „Deltaco“!
NLD Hartelijk dank dat u Deltaco heeft gekozen!
POL Dziękujemy, że wybrałeś Deltaco!
SPA ¡Gracias por elegir Deltaco!
SWE Tack för att ditt val av Deltaco!

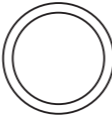
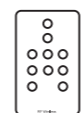
A x 1 	B x 1 	C x 1 	D x 2 	E x 1 	F x 1 	G x 8 	H x 4 		
I x 1 	J x 2 	K x 1 	L x 1 	M x 1 	N x 1 	O x 1 	P x 5 		
R x 1 	S x 4 	T x 1 Remote Control 							

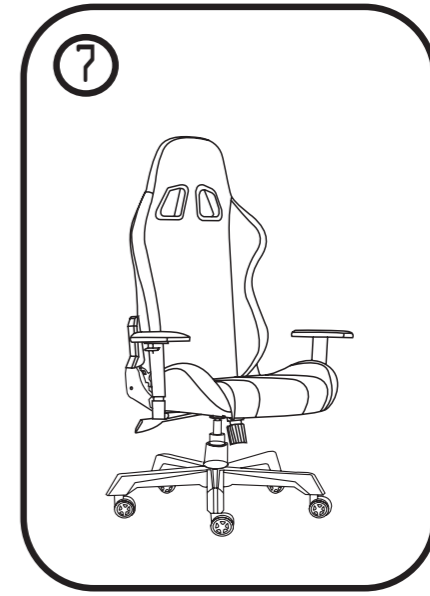
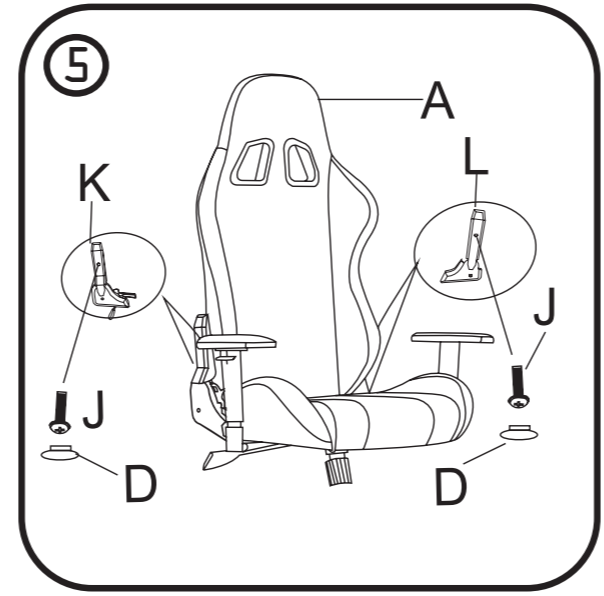
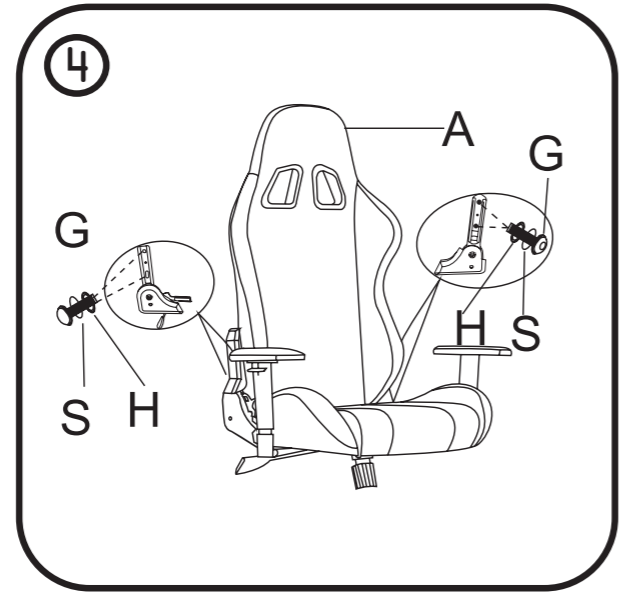
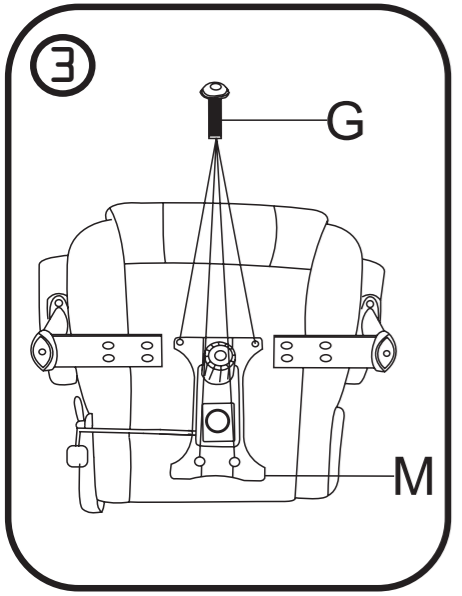
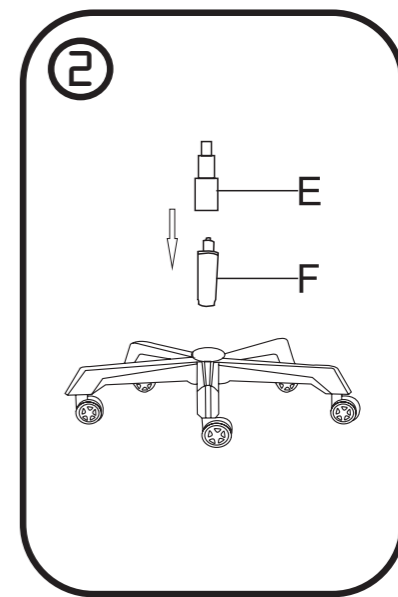
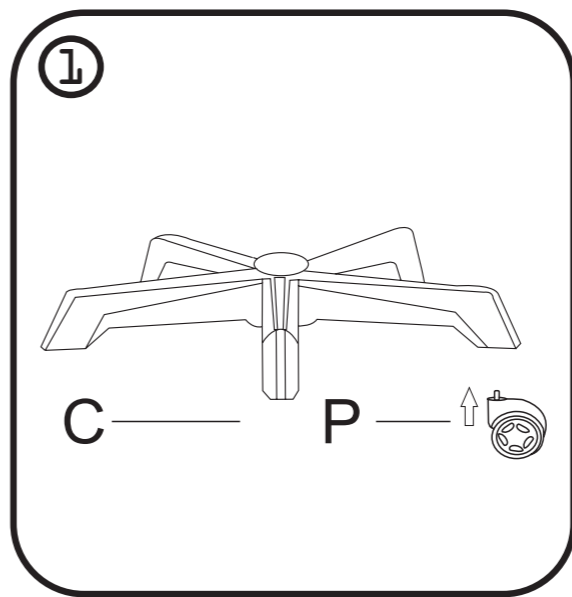

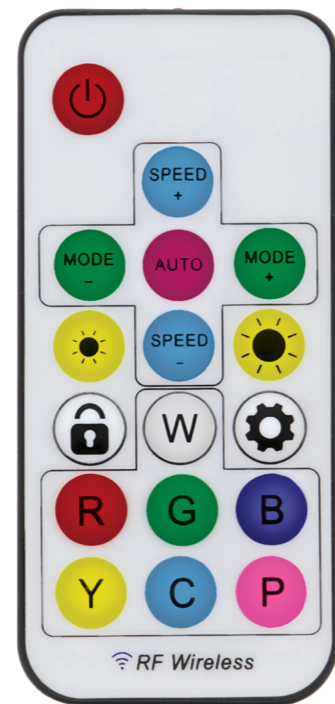
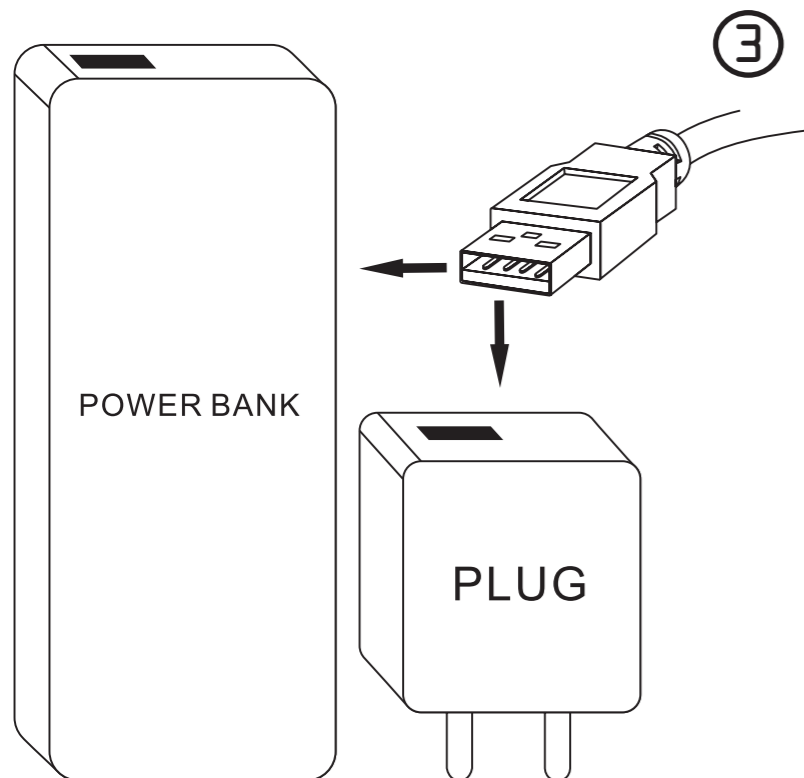
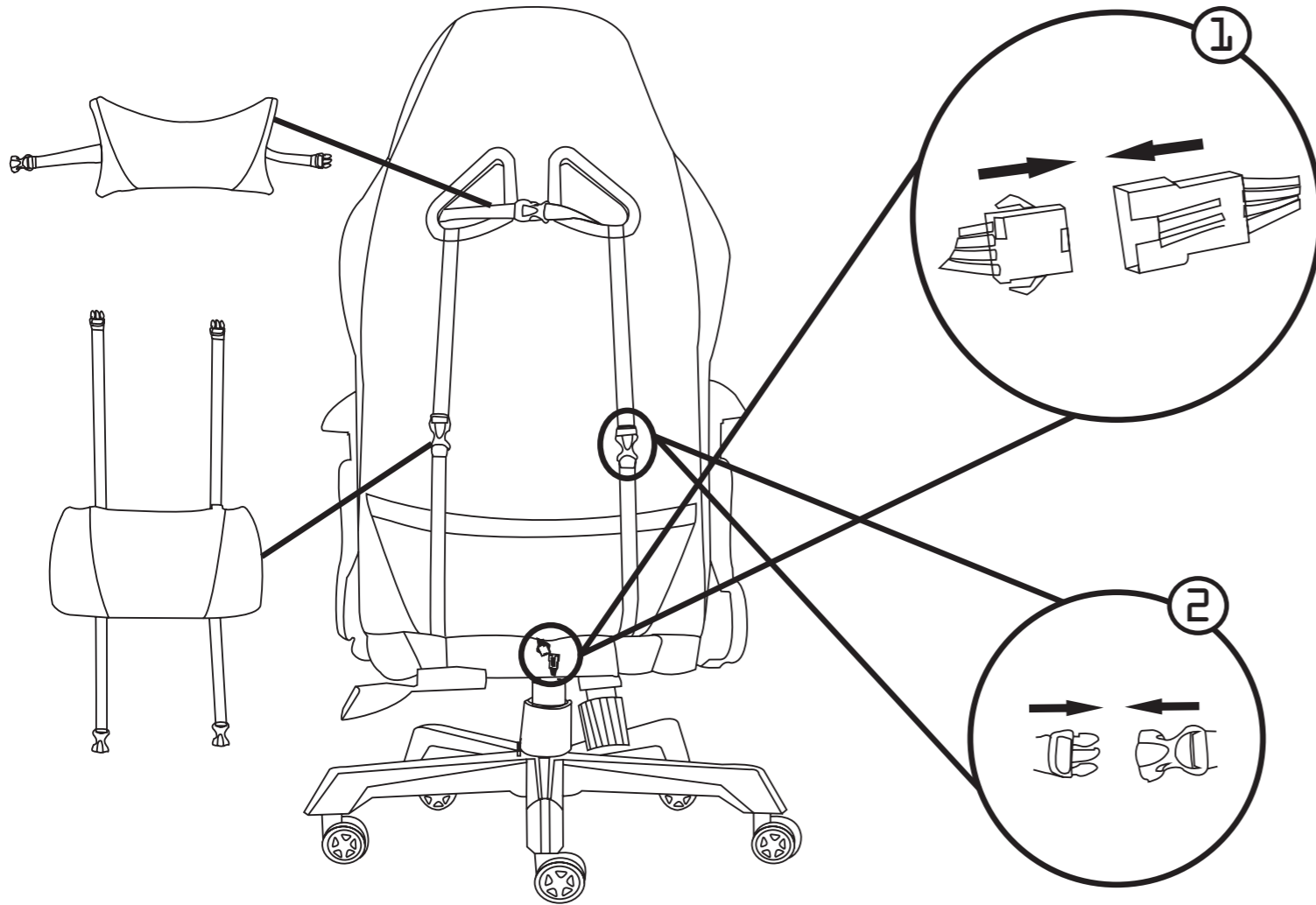

- 1 Свържете плоските захранващи конектори за постоянен ток.
- 2 Свържете заключващия механизъм на възглавницата за врата.
- 3 Свържете USB кабелът с 5V захранващо устройство.
 - 3.1 По желание: Външна батерия power bank (не е включена) като захранващо устройство без кабели.
 - 3.2 По желание: Използвайте USB зарядно (не е включено) като стабилно захранващо устройство. Също така можете да използвате и други USB захранващи устройства като компютър или лаптоп.

- G** = "G", активира LED режим зелено
- B** = "B", активира LED режим синьо
- W** = "W", активира LED режим бяло
- Y** = "Y", активира LED режим жълто
- C** = "C", активира LED режим тюркоаз
- P** = "P", активира LED режим пурпурно

LED режими

За да се движите сред 166 LED режима, натиснете "Mode+" или "Mode-".
 За да се движите сред другите 166 LED режими, натиснете "Auto" и след това "Mode+" или "Mode-".

Бутони за дистанционно управление

- = Бутон включване/изключван
- = "Auto", активира LED режим дъга
- = "Скорост +", увеличава LED скоростта
- = "Скорост -", намалява LED скоростта
- = увеличава LED интензитета
- = намалява LED интензитета
- = "Режим +", следващ LED режим
- = "Режим -", предишен LED режим
- = Бутон за присъединяване, за свързване на дистанционното със стола
- = Бутон настройки
- = "R", активира LED режим червено

Комбинации от бутони

Свържете дистанционното: Натиснете бутон за присъединяване 5 пъти. LED ще мига бързо в бяло, за да потвърди.
 Разединете дистанционното: Натиснете бутон за присъединяване 5 пъти. LED ще мига бавно в бяло, за да потвърди.
 Променете цвета на бутоните "R", "G" и "B" = Натиснете бутон за настройки 5 пъти. LED мига веднъж и става статична бяла, за да потвърди. Натиснете и задръжте "R" докато LED стане червена. Това се получава успешно за бутоните "R", "G" и "B". Натиснете бутон за настройки, за да потвърдите цвета.
 Променете количеството LED светлини: Натиснете бутон за настройки 5 пъти. LED мига веднъж и става статична бяла, за да потвърди. Натиснете "Mode+", за да увеличите количеството активни LED светлини.
 Натиснете "Mode-", за да увеличите количеството активни LED светлини.

Консумация на електроенергия
Консумацията на електроенергия се влияе силно от нивото на яркост на LED. Например: Консумацията на електроенергия се намалява наполовина, когато се намалява нивото на яркост с 1 стъпка от най-високата стойност.

Захранване

Използвайте с включения USB кабел (③)

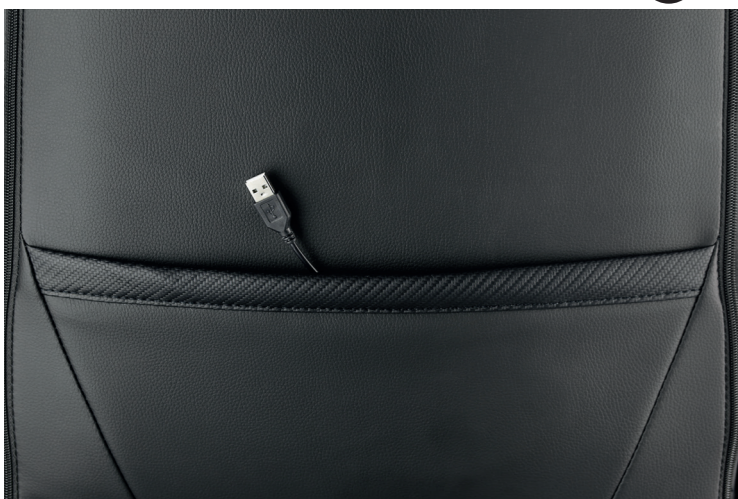

Поддръжка

Повече информация за продукта можете да откриете на www.deltaco.eu.
Свържете се с нас чрез e-mail: help@deltaco.eu.

- ① Forbind de to flade jævnstrøm stik med hinanden
- ② Klik nakkepudens klikspænder sammen.
- ③ Forbind USB kablet til en 5V strømkilde.

- 3.1 Valgfrit: Brug en Power bank (ikke inkluderet) som strømkilde for at slippe for løse kabler.
- 3.2 Valgfrit: Brug en USB strømforsyning (ikke inkluderet) som strømkilde for at opnå en stabil strømtilførsel. Andre USB strømkilder kan også benyttes. Såsom USB-porten på en computer eller bærbar computer.

Fjernbetjeningsknapper

-  = Tænd/Sluk knap
-  = "Auto", aktiverer regnbue LED-tilstand
-  = "Speed +", øger LED-hastigheden
-  = "Speed -", reducerer LED-hastigheden
-  = Øger LED-intensiteten
-  = Reducerer LED-intensiteten
-  = "Mode +", næste LED-tilstand
-  = "Mode -", forrige LED-tilstand
-  = forbindelse-knap, for at forbinde fjernbetjeningen til stolen
-  = Indstillings knap
-  = "R", aktiverer rød LED-tilstand

 = "G", aktiverer grøn LED-tilstand

 = "B", aktiverer blå LED-tilstand

 = "W", aktiverer hvid LED-tilstand

 = "Y", aktiverer gul LED-tilstand

 = "C", aktiverer turkis LED-tilstand

 = "P", aktiverer lilla LED-tilstand

LED-tilstande

For at skifte imellem de 166 forskellige LED-tilstande tryk på "Mode+" eller "Mode-".

For at skifte imellem de andre 166 LED-tilstande tryk på "Auto" og dernæst på "Mode+" eller "Mode-".

Knap kombinationer

Forbind fjernbetjeningen: Tryk på forbindelses-knappen fem gange. LED lyset blinker hurtigt hvidt som bekræftelse.

Afbryd fjernbetjeningen: Tryk på par-knappen fem gange. LED lyset blinker langsomt hvidt som bekræftelse.

Skift farve på knapperne "R", "G" og "B" = Tryk på knappen Indstillinger fem gange. LED lyset blinker én gang og skifter derefter til statisk hvidt som bekræftelse. Tryk på "R", indtil LED lyset bliver rødt. Dette fungerer for knapperne "R", "G" og "B". Tryk på indstillingerne for at bekræfte farven.

Skift antal LED-lamper: Tryk fem gange på indstillings-knappen. LED lyset blinker én gang og skifter derefter til statisk hvidt som bekræftelse. Tryk på "Mode +"

for at øge mængden af aktive LED-dioder.

Tryk på "Mode-" for at reducere mængden af aktive LED-dioder.

Strømforbrug

Strømforbruget påvirkes stærkt af lysstyrkeniveauet på LED-dioderne. Som eksempel: Strømforbruget reduceres til halvdelen, når du reducerer lysstyrkeniveauet et trin ned fra den højeste indstilling.

Strømtilførsel

Brug det medfølgende USB-kabel (③)



Support







Mere produktinformation kan findes på www.deltaco.eu.

Kontakt os via e-mail: help@deltaco.eu.

- 1 Schließen Sie die flachen Gleichstromanschlüsse an.
- 2 Schließen Sie die Schnalle des Nackenkissens an.
- 3 Schließen Sie das USB-Kabel an eine 5-V-Stromversorgung an.
 - 3.1. Optional: Ladegerät (nicht im Lieferumfang enthalten), um Kabel zu vermeiden.
 - 3.2. Optional: Verwenden Sie ein USB-Netzadapter (nicht im Lieferumfang enthalten) als stabile Stromversorgung. Sie können auch andere USB-Netzteile verwenden, z. B. einen Computer oder einen Laptop.

Fjernbetjeningsknapper

-  = Ein/Aus-Taste
-  = „Auto“ aktiviert den Regenbogen-LED-Modus
-  = „Speed +“ erhöht die LED-Geschwindigkeit
-  = „Speed -“ verringert die LED-Geschwindigkeit
-  = LED-Intensität erhöhen
-  = LED-Intensität verringern
-  = „Mode +“, nächster LED-Modus
-  = „Mode -“, vorheriger LED-Modus
-  = „Pair-Taste“ für Verbindung der Fernbedienung mit dem Stuhl
-  = Taste für Einstellungen

-  = „R“, aktiviert den roten LED-Modus
-  = „G“, aktiviert den grünen LED-Modus
-  = „B“, aktiviert den blauen LED-Modus
-  = „W“, aktiviert den weißen LED-Modus
-  = „Y“, aktiviert den gelben LED-Modus
-  = „C“ aktiviert den türkisfarbenen LED-Modus
-  = „P“ aktiviert den lila LED-Modus

LED-Modi

Um 166 LED-Modi zu durchlaufen, drücken Sie „Mode+“ oder „Mode-“.

Um die anderen 166 LED-Modi zu durchlaufen, drücken Sie „Auto“ und dann „Mode+“ oder „Mode-“.

Tastenkombinationen

Fernbedienung anschließen: Drücken Sie die Pair-Taste fünfmal. Zur Bestätigung blinkt die LED schnell weiß.

Fernbedienung trennen: 5-mal die Pair-Taste drücken. Zur Bestätigung blinkt die LED langsam weiß.

Um die Farbe der Tasten „R“, „G“ und „B“ zu ändern = drücken Sie die Einstelltaste fünfmal. Die LED blinkt einmal und wechselt zur Bestätigung zu statischem Weißlicht. Halten Sie „R“ gedrückt, bis die LED rot wird. Das funktioniert für die Tasten „R“, „G“ und „B“. Drücken Sie die Einstelltaste, um die Farbe zu bestätigen.

Anzahl der LED-Leuchten ändern: drücken Sie die Einstelltaste fünfmal. Die

LED blinkt einmal und wechselt zur Bestätigung zu statischem Weißlicht. Drücken Sie „Mode+“, um die Anzahl der aktiven LED-Leuchten zu erhöhen. Drücken Sie auf „Mode“, um die Anzahl der aktiven LED-Leuchten zu verringern.

Stromverbrauch
Der Stromverbrauch wird stark von der Helligkeit der LED beeinflusst. Beispiel: Der Energieverbrauch wird um die Hälfte reduziert, indem die höchste Helligkeitsstufe von der höchsten Einstellung in einem Schritt vermindert wird.

Leistung

Verwenden Sie das mitgelieferte USB-Kabel ()















Unterstützung

Weitere Produktinformationen finden Sie unter www.deltaco.eu.

Kontaktieren Sie uns per E-Mail: help@deltaco.eu.

- 1 Connect the flat DC power connectors.
- 2 Connect the neck pillow's buckle.
- 3 Connect the USB cable to a 5V power supply.
 - 3.1 Optional: Power bank (not included) as a power supply for freedom from cables.
 - 3.2 Optional: Use a USB power adapter (not included) as stable power supply. You can use other USB power supplies as well, such as a computer or laptop.

Remote control buttons

-  = On/off button
-  = „Auto“, activates rainbow LED mode
-  = „Speed +“, increases LED speed
-  = „Speed -“, decreases LED speed
-  = increase LED intensity
-  = decrease LED intensity
-  = „Mode +“, next LED mode
-  = „Mode -“, previous LED mode
-  = Pair button, to connect remote control to chair
-  = Settings button
-  = „R“, activates red LED mode
-  = „G“, activates green LED mode

 = "B", activates blue LED mode

 = "B", activates blue LED mode

 = "W", activates white LED mode

 = "Y", activates yellow LED mode

 = "C", activates turquoise LED mode

 = "P", activates purple LED mode

LED modes

To cycle through 166 LED modes press "Mode+" or "Mode-".

To cycle through the other 166 LED modes press "Auto" and then "Mode+" or "Mode-".

Button combinations

Connect remote control: Press pair button 5 times. LED will flash quickly in white, to confirm.

Disconnect remote control: Press pair button 5 times. LED will flash slowly in white, to confirm.

Change color of the buttons "R", "G" and "B" = Press the settings button 5 times. LED flashes once and changes to static white to confirm. Keep pressing "R" until the LED becomes red. This works for the buttons "R", "G" and "B". Press the settings button to confirm the color.

Change amount of LED lights: Press the settings button 5 times. LED flashes once and changes to static white to confirm.

Press "Mode+" to increase amount of active LED lights.

Press "Mode-" to decrease amount of active LED lights.

Power usage

The power usage is strongly affected by the brightness level of the LED. For example: The power usage is reduced to half as much when decreasing the brightness level with 1 step from the highest setting.

Power

Use with included USB cable ()



Support

More product information can be found at www.deltaco.eu.

Contact us by e-mail: help@deltaco.eu.

 Ühendage lamedad AV toiteühendused.

 Ühendage kaelapadja pannal.

 Ühendage USB-kaabel 5 V toiteallikaga.

3.1 Valikuline: Akupank (ei ole kaasas) kaablivaba toiteallikana.

3.2 Valikuline: Kasutage USB-toiteadapterit (ei ole kaasas) stabiilse toiteallikana. Võite samuti kasutada teisi USB-toiteallikaid, nagu laua- või sülearvuti.

Kaugjuhtimispuldi nupud

 = Sisse/välja nupp

 = „Automaatne“, aktiveerib vikerkaarevärvides valgusdiodi režiimi

 = „Kiirus +“, suurendab valgusdiodi kiirust

 = „Kiirus -“, vähendab valgusdiodi kiirust

 = suurendab valgusdiodi intensiivsust

 = vähendab valgusdiodi intensiivsust

 = „Režiim +“, järgmine valgusdiodi režiim

 = „Režiim -“, eelmine valgusdiodi režiim

 = Sidumisnupp, kaugjuhtimispuldi ühendamiseks tooliga

 = Seadistuste nupp

 = „R“, aktiveerib punase valgusdiodi režiimi

 = „G“, aktiveerib roheline valgusdiodi režiimi

 = „B“, aktiveerib sinise valgusdiodi režiimi

 = „W“, aktiveerib valge valgusdiodi režiimi

 = „Y“, aktiveerib kollase valgusdiodi režiimi

 = „C“, aktiveerib türkiissinise valgusdiodi režiimi

 = „P“, aktiveerib lilla valgusdiodi režiimi

Valgusdiodi režiimid

166 valgusdiodi režiimi vahel liikumiseks vajutage „Režiim +“ või „Režiim -“. Ülejäänud 166 valgusdiodi režiimi vahel liikumiseks vajutage „Automaatne“ ning seejärel „Režiim +“ või „Režiim -“.

Nupukombinatsioonid

Kaugjuhtimispuldi ühendamine: Vajutage sidumise nuppu 5 korda. Valgusdiod vilgub kinnituseks kiiresti valgelt. Kaugjuhtimispuldi lahti ühendamine: Vajutage sidumise nuppu 5 korda. Valgusdiod vilgub kinnituseks aeglaselt valgelt.

Nuppude „R“, „G“ ja „B“ värvuse muutmine = Vajutage seadistuste nuppu 5 korda. Valgusdiod vilgub ühe korra ja muutub kinnituseks püsivalt valgeks. Jätkake „R“ vajutamist kuni valgusdiod muutub punaseks. See töötab nuppudega „R“, „G“ ja „B“. Värvuse kinnitamiseks vajutage seadistuste nuppu.

Valgusdioditulede hulga muutmine: Vajutage seadistuste nuppu 5 korda. Valgusdiod vilgub ühe korra ja muutub kinnituseks püsivalt valgeks. Vajutage aktiivsete valgusdioditulede koguse suurendamiseks „Režiim +“.

Vajutage aktiivsete valgusdioditulede koguse vähendamiseks „Režiim -“.

Toitetarve

Toitetarvet mõjutab tugevalt valgusdiodi ereduse tase.

Näiteks: Vähendades eredust kõrgeimalt seadistuselt 1 astme võrra väheneb toitetarve pooleni.

Toide

Kasutage kaasasoleva USB-kaabliga (③)

**Tugi**





Täiendavad tooteteavet leiab aadressil www.deltaco.eu.

Võtke meiega ühendust e-posti teel: help@deltaco.eu.

- ① Kytke litteät tasavirtaliittimet.
- ② Asenna selkätyynyn kiinnike paikalleen.
- ③ Kytke USB-kaapeli 5 voltin virtalähteeseen.
 - 3.1 Valinnainen: varavirtalähde (ei tule mukana) mahdollistaa sen, että LED-valot voi ladata ilman kaapeleiden käyttöä.
 - 3.2 Valinnainen: virtasovitin (ei tule mukana) tarjoaa kaikkein vakaimman virransyötön. On mahdollista käyttää myös muun tyyppisiä virtalähteitä, esim. pöytäkonetta tai kannettavaa.

Kaukosäätimen painikkeet

-  = Virtakytin
-  = "Auto", aktivoi väriaallon
-  = "Speed +", suurentaa värien vaihtumisnopeutta
-  = "Speed -", pienentää värien vaihtumisnopeutta
-  = Suurena kirkkautta
-  = Pienennä kirkkautta
-  = "Mode +", seuraava valaistustila
-  = "Mode -", edellinen valaistustila
-  = Laiteparin muodostuspainike
-  = Asetuspainike
-  = "R", aktivoi kiinteän punaisen värin
-  = "G", aktivoi kiinteän vihreän värin

-  = "B", aktivoi kiinteän sinisen värin
-  = "W", aktivoi kiinteän valkoisen värin
-  = "Y", aktivoi kiinteän keltaisen värin
-  = "C", aktivoi kiinteän turkoosin värin
-  = "P", aktivoi kiinteän violetin värin

LED-valojen valaistustilat

Tuolissa on 166 valaistustilaa, joiden välillä voi siirtyä painikkeilla "Mode +" ja "Mode-".

Tämän lisäksi on 166 muuta valaistustilaa, joiden välillä voi siirtyä painamalla ensin painiketta "Auto" ja sen jälkeen painiketta "Mode +" tai "Mode-".

Painikeyhdistelmät

Kaukosäätimen kytkeminen: Paina laiteparin muodostuspainiketta viidesti. Tuolin valot vilkuttavat valkoista merkinä siitä, että kytkeminen onnistui.

Kaukosäätimen kytkennän purkaminen: Paina laiteparin muodostuspainiketta viidesti. Tuolin valot vilkuttavat valkoista merkinä siitä, että purkaminen onnistui.

Palauta painikkeiden "R", "G" ja "B" oletusväri: Paina asetuspainiketta viidesti. LED-valot vilkahtavat, ja niiden väri vaihtuu kiinteään valkoiseen. Jatka haluamasi väripainikkeen ("R", "G" tai "B") painamista, kunnes LED-valot näyttävät sopivaa väriä. Vahvista valinta asetuspainikkeella.

Muuta LED-valojen määrää: Paina asetuspainiketta viidesti. LED-valot vilkahtavat, ja niiden väri vaihtuu

kiinteään valkoiseen. Voit vaihtaa valojen määrää painikkeella "Mode +" ja pienentää sitä painikkeella "Mode-".

Virrankulutus

Virrankulutus vaihtelee sen mukaan, kuinka kirkas valoasetus on valittuna. Esimerkki: virrankulutus puolittuu, kun kirkkausasetusta pienentää yhden pykälän verran.

Virransyöttö

Käytä mukana tulevaa USB-kaapelia (③).

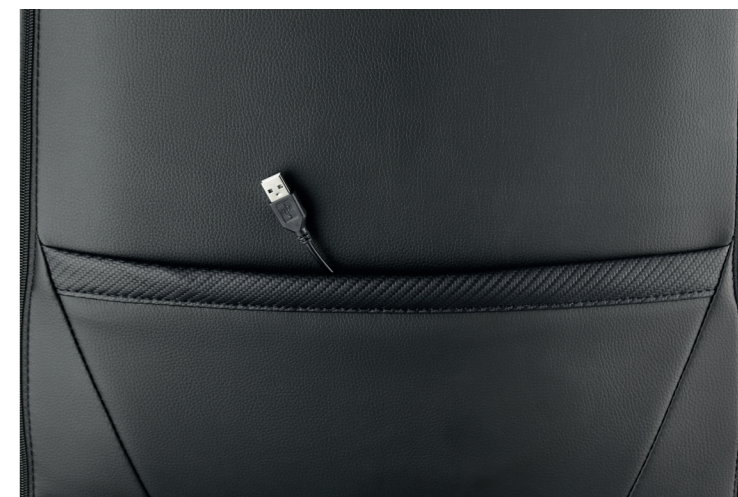







**Tuotetuki**







Tuotteesta on lisätietoja osoitteessa www.deltaco.eu.

Tukipalvelun sähköpostiosoite on info@deltaco.fi.

- 1 Branchez les connecteurs d'alimentation CC plats.
- 2 Connectez la boucle de l'oreiller tour de cou.
- 3 Connectez le câble USB à une alimentation 5 V.
 - 3.1 En option : bloc d'alimentation (non fourni) comme source d'alimentation pour vous libérer des câbles.
 - 3.2 En option : Utilisez un adaptateur secteur USB (non fourni) comme source d'alimentation stable. Vous pouvez également utiliser d'autres sources d'alimentation USB, telles qu'un ordinateur ou un ordinateur portable.

Boutons de la télécommande

-  = bouton marche / arrêt
-  = Auto », active le mode DEL arc-en-ciel
-  = Speed + », augmente la vitesse de la DEL.
-  = « Speed - », diminue la vitesse de la DEL
-  = augmente l'intensité de la DEL
-  = diminue l'intensité de la DEL
-  = « Mode + », mode DEL suivant
-  = « Mode - », mode DEL précédent
-  = Bouton d'appairage, pour connecter la télécommande au fauteuil
-  = bouton de paramètres

-  = « R », active le mode DEL rouges
-  = « G », active le mode DEL vertes
-  = « B », active le mode DEL bleues
-  = « W », active le mode DEL blanches
-  = « Y », active le mode DEL jaunes
-  = « C », active le mode DEL turquoise
-  = « P », active le mode DEL violettes

Modes de DEL

Pour parcourir les 166 modes de DEL, appuyez sur « Mode + » ou « Mode - ». Pour faire défiler les 166 autres modes de DEL, appuyez sur « Auto » puis sur « Mode + » ou « Mode- ».

Combinaisons de boutons

Connecter la télécommande : Appuyez 5 fois sur le bouton d'appairage. La DEL clignotera rapidement en blanc pour confirmer.

Déconnecter la télécommande : Appuyez 5 fois sur le bouton d'appairage. La DEL clignotera lentement en blanc pour confirmer.

Changer la couleur des boutons « R », « G » et « B » = Appuyez 5 fois sur le bouton de réglage. La DEL clignote une fois et passe au blanc statique pour confirmer. Continuez à appuyer sur « R » jusqu'à ce que la DEL devienne rouge.

Cela fonctionne pour les boutons « R », « G » et « B ». Appuyez sur le bouton de configuration pour confirmer la couleur. Modifier le nombre de DEL : appuyez 5 fois

sur le bouton de réglage. La DEL clignote une fois et passe au blanc statique pour confirmer. Appuyez sur « Mode + » pour augmenter le nombre de DEL actives. Appuyez sur « Mode - » pour réduire le nombre de DEL actives.

Consommation d'énergie

La consommation d'énergie est fortement affectée par le niveau de luminosité de la DEL.

Par exemple : la consommation d'énergie est réduite de moitié lorsque vous diminuez le niveau de luminosité d'un niveau par rapport au réglage le plus élevé.

Alimentation électrique

Utiliser avec le câble USB fourni ().



Assistance

Plus d'information sur le produit sur le site www.deltaco.eu.

Contactez-nous par e-mail : help@deltaco.eu.

- 1 Csatlakoztassa a lapos DC csatlakozókat.
- 2 Kapcsolja össze a nyakpárna csatját.
- 3 Csatlakoztassa az USB kábelt egy 5V-os áramforráshoz.
 - 3.1 Opcionális: A kábelek kiküszöbölése érdekében áramforrásként használjon külső akkumulátort (ezt a csomag nem tartalmazza).
 - 3.2 Opcionális: Stabil áramforrásként használjon USB-s hálózati adaptert (ezt a csomag nem tartalmazza). Használhat más USB bemenetű áramforrásokat is, például egy számítógépet vagy egy laptopot.

A távirányító gombjai

-  = be- és kikapcsológomb
-  = az „Auto” gomb aktiválja a szivárványszínű LED üzemmódot
-  = a „Speed+” gomb növeli a LED sebességét
-  = A „Speed-” gomb csökkenti a LED sebességét
-  = növeli a LED fényerejét
-  = csökkenti a LED fényerejét
-  = „Mode+” gomb a következő LED üzemmódot
-  = „Mode-” gomb az előző LED üzemmódot
-  = párosító gomb a távirányító és a szék összekapcsolásához
-  = beállítások gomb
-  = az „R” aktiválja a piros LED üzemmódot

- G** = a „G” aktiválja a zöld LED üzemmódot
- B** = a „B” aktiválja a kék LED üzemmódot
- W** = a „W” aktiválja a fehér LED üzemmódot
- Y** = az „Y” aktiválja a sárga LED üzemmódot
- C** = a „C” aktiválja a türkiz LED üzemmódot
- P** = a „P” aktiválja a lila LED üzemmódot

LED üzemmódok

A 166 LED üzemmód futtatásához nyomja meg a „Mode+” vagy a „Mode-” gombot.

A másik 166 LED üzemmód futtatásához nyomja meg az „Auto” gombot, majd a „Mode+” vagy a „Mode-” gombot.

Gombkombinációk

Csatlakozás a távirányítóhoz: Nyomja meg ötször a párosító gombot. Sikeres csatlakozáskor a LED gyorsan és féhéren fog felvillanni.

A távirányító csatlakozásának bontásához: Nyomja meg ötször a párosító gombot. A kapcsolat bontásakor a LED lassan és féhéren fog felvillanni.

Az „R”, „G” és „B” gombok színének megváltoztatásához nyomja meg ötször a beállításkor a LED egyszer felvillan, majd folyamatosan féhéren világít. Tartva lenyomva az „R” gombot addig, amíg a LED pirosra vált. Ugyanígy járjon el az „R”, „G” és „B” gombok esetén. Nyomja meg a beállításkor a szín jóváhagyásához.

A LED fények mennyiségének megváltoztatása: Nyomja meg ötször a beállításkor a művelet

végrehajtásakor a LED egyszer felvillan, majd folyamatosan féhéren világít. Nyomja meg a „Mode+” gombot az aktív LED fények számának növeléséhez.

Nyomja meg a „Mode-” gombot az aktív LED fények számának csökkentéséhez.

Energiafogyasztás

Az energiafogyasztást erősen befolyásolja a LED fényereje.

Például: Az energiafogyasztás felére csökken, ha a fényerőt a legmagasabb beállításhoz képest egyel alacsonyabb fokozatra állítjuk.

Töltés

Használja a csomagban található USB kábelt().



Terméktámogatás

További termékinformációt az alábbi honlapon talál: www.deltaco.eu. Keressen minket e-mail címünkön: help@deltaco.eu.

- 1** Savienojiet plakanos līdzstrāvas savienotājus.
- 2** Piestipriniet kakla spilvena sprādzi.
- 3** Savienojiet USB kabeli ar 5V strāvas avotu.
 - 3.1 Pēc izvēles: Ārējais akumulators (nav ietverts komplektā) kā strāvas avots, lai samazinātu vadu daudzumu.
 - 3.2 Pēc izvēles: Kā stabilu strāvas avotu izmantojiet USB strāvas adapteru (nav ietverts komplektā).
Varat izmantot arī citus USB strāvas avotus, piemēram, datoru vai klēpj datoru.

A távirányító gombjai

-  = Ieslēgšanas/izslēgšanas poga
-  = „Auto”, aktivizē varavīksnes LED režīmu
-  = „Speed +”, palielina LED ātrumu
-  = „Speed -”, samazina LED ātrumu
-  = palielina LED intensitāti
-  = samazina LED intensitāti
-  = „Mode +”, nākamais LED režīms
-  = „Mode -”, iepriekšējais LED režīms
-  = Sapārošanas poga, lai pieslēgtu krēsla tāl vadību
-  = Iestatījumu poga
-  = „R”, aktivizē sarkana LED režīmu

- G** = „G”, aktivizē zaļa LED režīmu
- B** = „B”, aktivizē zila LED režīmu
- W** = „W”, aktivizē balta LED režīmu
- Y** = „Y”, aktivizē dzeltena LED režīmu
- C** = „C”, aktivizē tirkīza LED režīmu
- P** = „P”, aktivizē violeto LED režīmu

LED režīmi

Lai izietu cauri 166 LED režīmiem, piespiediet „Mode+” vai „Mode-”.
Lai izietu cauri pārējiem 166 LED režīmiem, piespiediet „Auto” un tad „Mode+” vai „Mode-”.

Pogu kombinācijas

Pieslēdziet tāl vadību: 5 reizes piespiediet sapārošanas pogu.
Apstiprinājumam ātri mirgos balts LED.
Atslēdziet tāl vadību: 5 reizes piespiediet sapārošanas pogu. Apstiprinājumam lēni mirgos balts LED.

Mainiet pogu krāsu „R”, „G” un „B” = 5 reizes piespiediet iestatījumu pogu.
Apstiprinājumam vienreiz nomirgo un sāk nepārtraukti degt balts LED.

Turpiniet spiest „R”, līdz LED paliek sarkans. Tas darbojas pogām „R”, „G” un „B”. Piespiediet iestatījumu pogu, lai apstiprinātu krāsu.

Mainiet LED gaismu skaitu. 5 reizes piespiediet iestatījumu pogu.

Apstiprinājumam vienreiz nomirgo un sāk nepārtraukti degt balts LED. Lai palielinātu aktīvo LED gaismu skaitu, piespiediet „Mode+”.

Lai samazinātu aktīvo LED gaismu skaitu, piespiediet „Mode-“.

Strāvas patēriņš

Strāvas patēriņu ievērojami ietekmē LED spilgtuma līmenis.

Piemēram: Strāvas patēriņš uz pusi samazinās, ja spilgtuma līmeni padara par 1 soli mazāku nekā augstāko iestatījumu.

Jauda

Izmantojiet ar komplektā ietverto USB kabeli (③).



Atbalsts

Vairāk informācijas par precēm atrodama tīmekļa vietnē www.deltaco.eu.

Sazinieties ar mums, izmantojot e-pastu: help@deltaco.eu.

① Prijunkite plokščias DC maitinimo jungtis.

② Prijunkite kaklo pagalvės sagtį.

③ Prijunkite USB laidą prie 5V maitinimo šaltinio.

3.1 Pasirinktina: Atsarginis maitinimo šaltinis (Power bank) (nepridedamas), norint išvengti laidų.

3.2 Pasirinktina: Naudokite USB maitinimo adapterį (nepridedamas) kaip nuolatinį maitinimo šaltinį. Taip pat galite naudoti kitus USB maitinimo šaltinius, pvz., stacionarųjį arba nešiojamąjį kompiuterį.

Nuotolinio valdymo mygtukai

 = Įjungimo/išjungimo mygtukas

 = „Auto“ suaktyvina vaivorykštinių LED režimą

 = „Speed +“ padidina LED greitį

 = „Speed -“ sumažina LED greitį

 = padidina LED intensyvumą

 = sumažina LED intensyvumą

 = „Mode+“ įjungia kitą LED režimą

 = „Mode-“ grąžina ankstesnį LED režimą

 = Susiejimo mygtukas, skirtas susieti nuotolinio valdymo pultelį su kėde

 = Nustatymų mygtukas

 = „R“ suaktyvina raudonos spalvos LED režimą

 = „G“, aktivizė žaļa LED režimu

 = „B“, aktivizė žila LED režimu

 = „W“, aktivizė balta LED režimu

 = „Y“, aktivizė dzeltena LED režimu

 = „C“, aktivizė tirkiza LED režimu

 = „P“, aktivizė violeta LED režimu

LED režimas

Norėdami pereiti per 166 LED režimus, spauskite „Mode+“ arba „Mode-“.

Norėdami pereiti per kitus 166 LED režimus, spauskite „Auto“, o tada „Mode+“ arba „Mode-“.

Mygtukų kombinacijos

Nuotolinio valdymo pultelio prijungimas: 5 kartus paspauskite susiejimo mygtuką. LED šviesos greitai sumirksės baltai taip patvirtindamos veiksmą.

Nuotolinio valdymo pultelio atjungimas: 5 kartus paspauskite susiejimo mygtuką. LED šviesos lėtai sumirksės baltai taip patvirtindamos veiksmą.

Norėdami pakeisti mygtukų „R“, „G“ ir „B“ spalvą = 5 kartus paspauskite nustatymų mygtuką. LED šviesos sumirksi vieną kartą ir pasikeičia į statišką baltą šviesą taip patvirtindamos veiksmą. Toliau spauskite „R“, kol LED šviesos taps raudonos. Šį veiksmą galima atlikti su mygtukais „R“, „G“ ir „B“. Paspauskite nustatymų mygtuką, kad patvirtintumėte spalvą.

LED šviesų kiekio pakeitimas: 5 kartus paspauskite nustatymų mygtuką. LED šviesos

sumirksi vieną kartą ir pasikeičia į statišką baltą šviesą taip patvirtindamos veiksmą. Paspauskite „Mode+“, kad padidintumėte aktyvių LED šviesų kiekį. Paspauskite „Mode-“, kad sumažintumėte aktyvių LED šviesų kiekį.

Energijos naudojimas

Energijos naudojimą stipriai veikia LED šviesų ryškumo lygis.

Pavyzdžiui: Energijos naudojimas sumažinamas perpus 1 žingsniu pakeičiant aukščiausius ryškumo nustatymus.

Maitinimas

Naudokite su pridėdamu USB laidu (③).

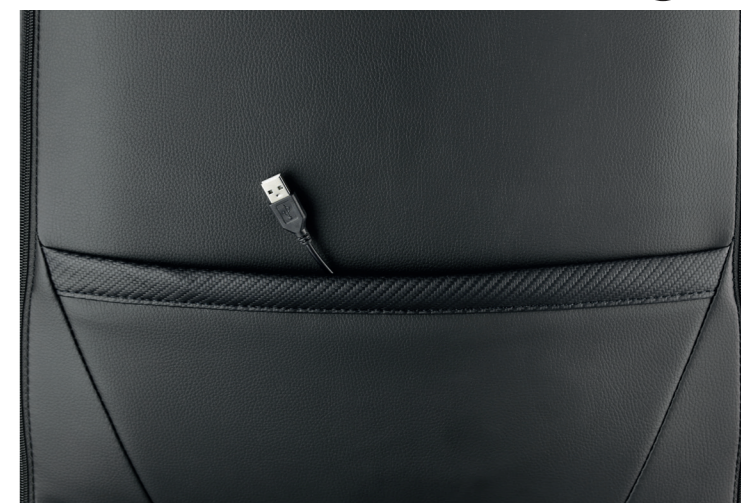

Pagalba







Daugiau informacijos žiūrėkite www.deltaco.eu.

Susisiekite su mumis el. paštu: help@deltaco.eu.

- 1 Sluit de platte DC voedingsconnectoren aan.
- 2 Sluit de gesp van nekkussen aan.
- 3 Sluit de USB-kabel op de voedingsbron van 5V aan.
 - 3.1 Optioneel: draagbare oplader (niet inbegrepen) als de voedingsbron voor vrijheid van kabels.
 - 3.2 Optioneel: gebruik een USB-stroomadapter (niet inbegrepen) als stabiele voedingsbron. U kunt ook andere USB-voedingsbronnen gebruiken, bijvoorbeeld een computer of een laptop.

Knoppen van afstandsbediening

-  = Aan/uit-knop
-  = "Auto", activeert regenboog LED-stand
-  = "Speed +", verhoogt LED-snelheid
-  = "Speed -", vermindert LED-snelheid
-  = verhoogt LED-intensiteit
-  = vermindert LED-intensiteit
-  = "Mode +", volgende LED-stand
-  = "Mode -", vorige LED-stand
-  = Koppelingsknop, om de afstandsbediening op de stoel aan te sluiten
-  = Instellingenknop
-  = "R", activeert rode LED-stand

-  = "G", activeert groene LED-stand
-  = "B", activeert blauwe LED-stand
-  = "W", activeert witte LED-stand
-  = "Y", activeert gele LED-stand
-  = "C", activeert turquoise LED-stand
-  = "P", activeert paarse LED-stand

LED-standen

Om door 166 LED-standen te draaien druk op de knop "Mode+" of "Mode-".
 Om door de overige 166 LED-standen te draaien druk op de knop "Auto" en dan op "Mode+" of "Mode-".

Knoppencombinaties

Afstandsbediening aansluiten: Druk op de koppelingsknop 5 keer. LED knippert snel om de koppeling te bevestigen.
 Afstandsbediening loskoppelen: Druk op de koppelingsknop 5 keer. LED knippert langzaam in wit om de loskoppeling te bevestigen.

De kleuren van de knoppen "R", "G" en "B" veranderen = Druk op de instellingenknop 5 keer. LED knippert eenmaal en verandert in wit om de verandering te bevestigen. Houd de knop "R" ingedrukt totdat de LED wordt rood. Dat werkt voor de knoppen "R", "G" en "B". Druk op de instellingenknop om de kleur te bevestigen.

Aantal van LED-lichten veranderen: Druk op de instellingenknop 5 keer. LED knippert eenmaal en verandert in wit om de verandering te bevestigen. Druk op "Mode+" om het aantal van actieve LED-lichten te verhogen.

Stroomverbruik

Het stroomverbruik wordt sterk beïnvloedt door een helderheidsniveau van LED. Bijvoorbeeld: het stroomverbruik wordt verminderd tot half zo groot als het helderheidsniveau met 1 stap van de hoogste instelling wordt verlaagd.

Stroom

Gebruik met geleverde USB-kabel Maitinimas Naudokite su pridedamu USB laidu (3).



Ondersteuning

Voor meer informatie bezoek www.deltaco.eu.
 Neem contact met ons op: help@deltaco.eu.

- 1 Podłącz płaskie złącza zasilania DC.
- 2 Zamocuj poduszkę pod kark.
- 3 Podłącz kabel USB do zasilacza 5V.
 - 3.1 Opcjonalnie: Power bank (nie wchodzi w skład zestawu) jako zasilacz zapewniający wolność od kabli.
 - 3.2 Opcjonalnie: Użyj zasilacza USB (nie wchodzi w skład zestawu) jako stabilnego źródła zasilania. Możesz również korzystać z innych źródeł zasilania USB, takich jak np. komputer lub laptop.

Przyciski pilota

-  = Włącz/Wyłącz
-  = „Auto”, aktywuje tęczy tryb LED
-  = „Speed +”, zwiększa prędkość LED
-  = „Speed +”, zmniejsza prędkość LED
-  = zwiększa intensywność LED
-  = zmniejsza intensywność LED
-  = „Mode +”, następny tryb LED
-  = „Mode +”, poprzedni tryb LED
-  = Przycisk parowania, podłącz pilot do fotela
-  = Przycisk ustawień
-  = „R”, aktywuje czerwony tryb LED
-  = „G”, aktywuje zielony tryb LED

- B** = „B”, aktywuje niebieski tryb LED
- W** = „W”, aktywuje biały tryb LED
- Y** = „Y”, aktywuje żółty tryb LED
- C** = „C”, aktywuje turkusowy tryb LED
- P** = „P”, aktywuje fioletowy tryb LED

Tryby LED

Aby przejść przez 166 trybów LED, naciśnij „Mode +” lub „Mode-”.

Aby przejść przez inne 166 trybów LED, naciśnij „Auto”, a następnie „Mode +” lub „Mode-”.

Kombinacje przycisków

Podłącz pilot: Naciśnij przycisk parowania 5 razy. Dioda LED szybko zamiga na biało, aby potwierdzić.

Odłącz pilot: Naciśnij przycisk parowania 5 razy. Dioda LED powoli zamiga na biało, aby potwierdzić.

Zmiana koloru przycisków „R”, „G” i „B” = Naciśnij przycisk ustawień 5 razy. Dioda LED raz mignie i zmieni kolor na biały, aby potwierdzić. Naciskaj „R”, aż dioda LED zmieni kolor na czerwony. To działa dla przycisków „R”, „G” i „B”. Naciśnij przycisk ustawień, aby zatwierdzić kolor.

Zmiana ilości świateł LED: Naciśnij przycisk ustawień 5 razy. Dioda LED raz mignie i zmieni kolor na biały, aby potwierdzić. Naciśnij „Mode+”, aby zwiększyć ilość aktywnych świateł LED. Naciśnij „Mode-”, aby zmniejszyć ilość aktywnych świateł LED.

Zużycie energii

Poziom jasności LEDów ma duży wpływ na zużycie energii.

Na przykład: Zużycie energii zmniejsza się o połowę, gdy zmniejszamy poziom jasności o 1 w stosunku do najwyższego ustawienia.



Zasilanie

Używaj z załączonym kablem USB ().













Pomoc

Więcej informacji o produkcie można znaleźć na stronie www.deltaco.eu. Skontaktuj się z nami poprzez e-mail: help@deltaco.eu.

-  Conecte los conectores de alimentación de CC.
-  Conecte la hebilla de la almohadilla de cuello.
-  Conecte el cable USB a una fuente de alimentación de 5V.
 - 3.1 Opcional: banco de alimentación (no incluido) como fuente de alimentación sin cables.
 - 3.2 Opcional: adaptador de alimentación USB (no incluido) como fuente de alimentación continua. También puede utilizar otras fuentes de alimentación USB, como un ordenador de mesa o un ordenador portátil.

Botones de control remoto

-  = botón de Encender/Apagar
-  = “Auto”, activar el modo LED arco iris
-  = “Speed +”, aumentar la velocidad de LED
-  = “Speed -”, disminuir la velocidad de LED
-  = aumentar la intensidad de LED
-  = disminuir la intensidad de LED
-  = “Mode +”, modo LED siguiente
-  = “Mode -”, modo LED anterior
-  = Botón para conectar el control remoto con la silla.
-  = Botón de configuración
-  = “R”, activa modo de LED rojo
-  = “G”, activa modo de LED verde

- B** = “B”, activa modo de LED azul
- W** = “W”, activa modo de LED blanco
- Y** = “Y”, activa modo de LED amarillo
- C** = “C”, activa modo de LED celeste
- P** = “P”, activa modo de LED rosa

Modos de LED

Para pasar por 166 modos de LED, presione “Modo +” o “Modo-”.

Para pasar por los otros 166 modos de LED, presione “Auto” y luego “Modo +” o “Modo-”.

Combinaciones de botones

Para conectar el control remoto: presione el botón emparejamiento (“pair”) 5 veces. El LED parpadeará rápidamente con luz blanca para confirmar.

Desconectar el control remoto: presione el botón de emparejamiento (“pair”) 5 veces. El LED parpadeará lentamente con luz blanca para confirmar.

Para cambiar el color de los botones “R”, “G” y “B” = Presione el botón de configuración 5 veces. El LED parpadea una vez y la luz blanca se queda sin parpadear para confirmar. Mantenga presionado el botón “R” hasta que el LED se vuelva rojo. Esto funciona para los botones “R”, “G” y “B”. Pulse el botón de configuración para confirmar el color.

Para cambiar la cantidad de luces LED: presione el botón de configuración 5 veces. El LED parpadea una vez y la luz blanca se queda sin parpadear para confirmar. Presione “Modo +” para aumentar

la cantidad de luces LED activas. Presione "Modo-" para disminuir la cantidad de luces LED activas.

Consumo de energía

El consumo de energía está condicionado por el nivel de brillo de LED. Por ejemplo: el uso de energía se reduce a la mitad cuando se reduce el nivel de brillo en 1 nivel desde la configuración más alta.

Energía

Conectarse con cable USB incluido (③).



Servicio técnico





Más información en la página web www.deltaco.eu.

Contacta con nosotros por correo electrónico: help@deltaco.eu.

- ① Anslut de platta strömkontakterna (Likström).
- ② Koppla ihop nackkuddens spänne.
- ③ Anslut USB-kabeln till en 5V-strömkälla.
 - 3.1 Valfritt: power bank (ingår ej) som strömförsörjning för att vara fri från kablar.
 - 3.2 Valfritt: Använd en USB-strömadapter (ingår ej) för stabil strömförsörjning. Du kan också använda andra USB-strömförsörjningskällor, till exempel en dator eller en bärbar dator.

Fjärrkontrollens knappar

-  = På/av-knapp
-  = "Auto", aktiverar lysdiodernas regnbågsläge
-  = "Speed +", ökar lysdiodernas hastighet
-  = "Speed -", minskar lysdiodernas hastighet
-  = öka lysdiodernas intensitet
-  = minska lysdiodernas intensitet
-  = "Mode +", nästa lysdiodläge
-  = "Mode -", föregående lysdiodläge
-  = Parkopplingsknapp, för att ansluta fjärrkontrollen till stolen
-  = Inställningsknapp
-  = "R", aktiverar rött lysdiodläge
-  = "G", aktiverar grönt lysdiodläge

-  = "B", aktiverar blått lysdiodläge
-  = "W", aktiverar vitt lysdiodläge
-  = "Y", aktiverar gult lysdiodläge
-  = "C", aktiverar turkost lysdiodläge
-  = "P", aktiverar lila lysdiodläge

Lysdiodlägen

För att gå igenom 166 lysdiodlägen trycker du på "Mode +" eller "Mode-". För att gå igenom de andra 166 lysdiodlägena trycker du på "Auto" och sedan "Mode +" eller "Mode-".

Knappkombinationer

Anslut fjärrkontrollen: Tryck på parkopplingsknappen 5 gånger. Lysdioden bekräftar genom att blinka snabbt i vitt. Koppla bort fjärrkontrollen: Tryck på parkopplingsknappen 5 gånger. Lysdioden bekräftar genom att blinka långsamt i vitt.

Ändra färg på knapparna "R", "G" och "B" = Tryck på inställningsknappen 5 gånger. Lysdioden blinkar en gång och ändrar till statisk vit för att bekräfta. Fortsätt trycka på "R" tills lysdioden lyser rött. Detta fungerar för knapparna "R", "G" och "B". Tryck på inställningsknappen för att bekräfta färgen.

Ändra mängden lysdioder: Tryck på inställningsknappen 5 gånger. Lysdioden bekräftar genom att blinka en gång och ändrar till statisk vit. Tryck på "Mode +" för att öka mängden aktiva lysdioder. Tryck på "Mode-" för att minska antalet aktiva lysdioder.

Strömförbrukning

Strömförbrukningen påverkas starkt av lysdiodernas ljusstyrka. Till exempel: Strömförbrukningen minskar till hälften så mycket när du minskar ljusstyrkans nivå med ett steg från högsta inställningen.

Strömförsörjning

Använd medföljande USB-kabel (③).



Support

Mer produktinformation finns på www.deltaco.eu.

Kontakta oss via e-post: help@deltaco.eu.



DELTACO GAMING

FREE SUPPORT

ENG help@deltaco.eu

SWE help@deltaco.se (0200-877771)

FIN info@deltaco.fi (020 712 0390)

DAN help@deltaco.dk

NOR help@deltaco.no

GAM-080

Distributed by SweDeltaco AB / www.deltaco.eu / Made in China

 SweDeltaco AB, Glasfibergatan 8, 125 45 Älvsjö, Sweden