

Alle Rechte vorbehalten / all rights reserved ZVK GmbH D-94244 Teisnach Technologiecampus 2 Germany Phone: +49 9923 804379-0 Fax: +49 9923 804379-50 www.zvk-gmbh.de alle Angaben ohne Gewähr

Technisches Datenblatt / technical Datasheet

Spleiß-Einschubmodul für Baugruppenträger 19" 3HE / 7TE

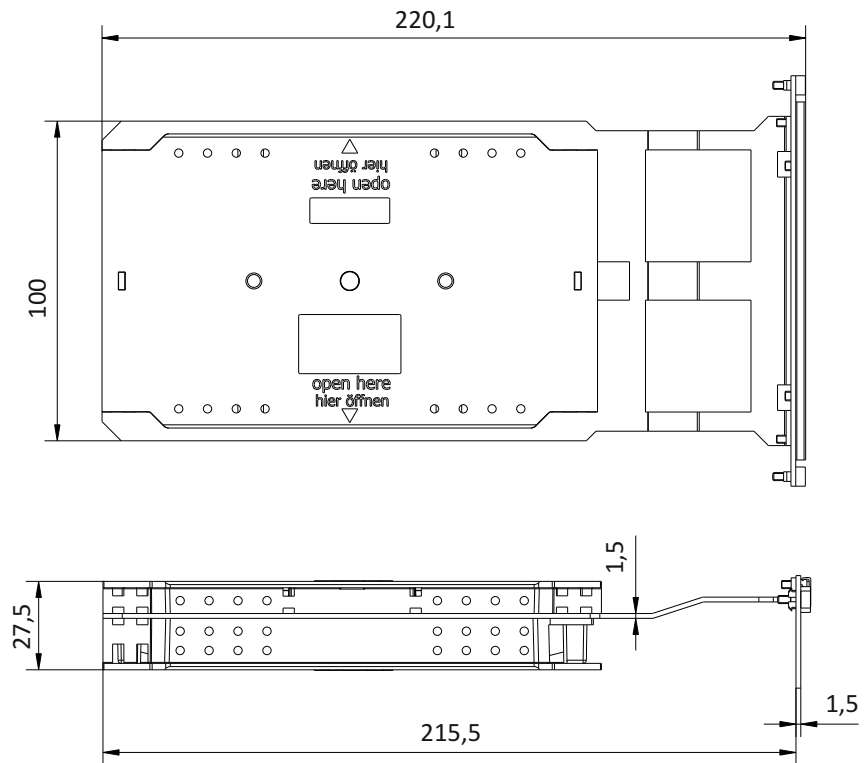
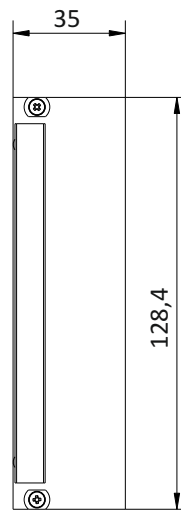
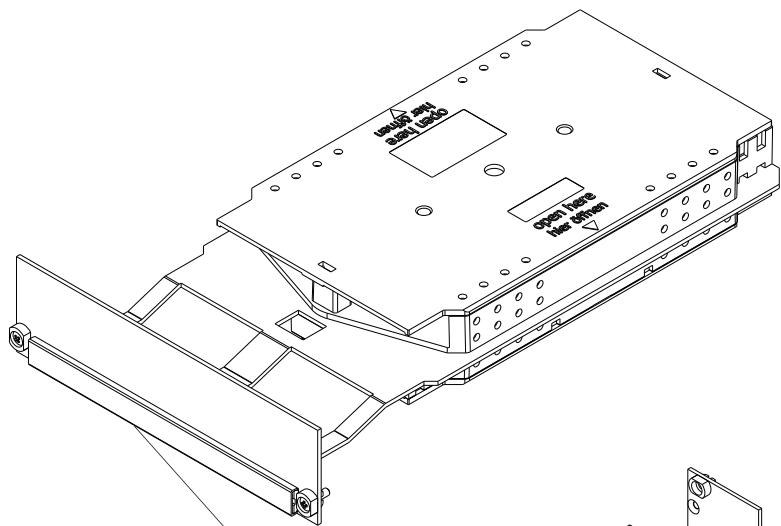

Optional:
Beschriftungsset inkl.
Befestigungsschrauben

Bestellcode:
AVZBTK112

Material		Material
Frontplatte	Aluminium / Aluminium	Front plate
Einschub	Aluminium / Aluminium	Plug-in

Frontvarianten siehe Seite 2

a	Neuerstellung	18.12.18	LP	gez. / drawn	18.12.2018	LP
				gepr. / appr.	18.12.2018	MJ
Änd./ rev. Index	Änderung/ revision code	Datum/ date	Name/ name	Titel / titel: EasyLan® Spleiß-Einschubmodul 19" 3HE / 7TE		
				Artikelnummer / article number: ZN-FO181510		
				Maße / Dimensions: mm		
				Original: DIN A4		
				Blatt / sheet 1 von / of 2		

Alle Rechte vorbehalten / all rights reserved. ZVK GmbH D-94244 Teisnach Technologiecampus 2 Germany Phone: +49 9923 804379-0 Fax: +49 9923 804379-50 www.zvk-gmbh.de alle Angaben ohne Gewähr

1 2 3 4 5 6 7 8

A

B

C

D

E

F

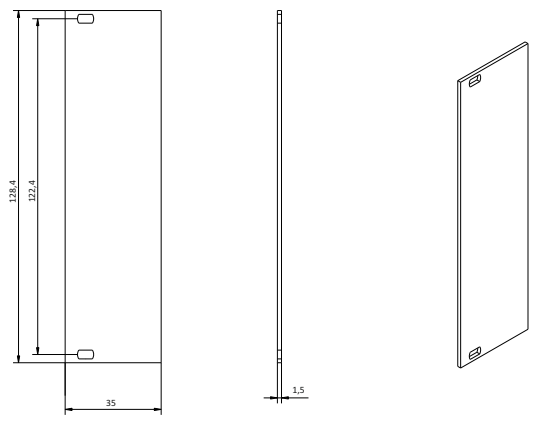

6x SC-Duplex /
6x LC-Quad

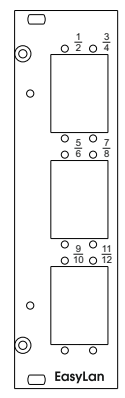

6x SC-Simplex
6x LC-Duplex

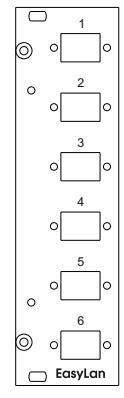

12x SC-Simplex
12x E2000-Simplex

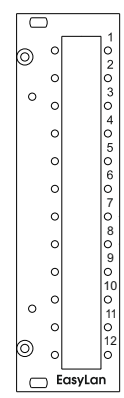

6x E2000 Compact
DX-Channels

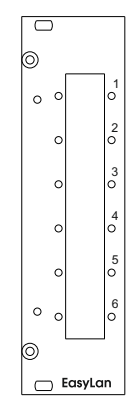

Adapterdaten: siehe separates Datenblatt

a	Neuerstellung	18.12.18	LP	gez. / drawn	18.12.2018	LP
				gepr. / appr.	18.12.2018	MJ
Titel / titel:				EasyLan® Spleiß-Einschubmodul 19" 3HE / 7TE		
Änd./rev. Index				Artikelnummer / article number: ZN-FO181510		
				Maße / Dimensions: mm		
				Original: DIN A4		
				Blatt / sheet 2 von / of 2		

1 2 3 4 5 6 7 8