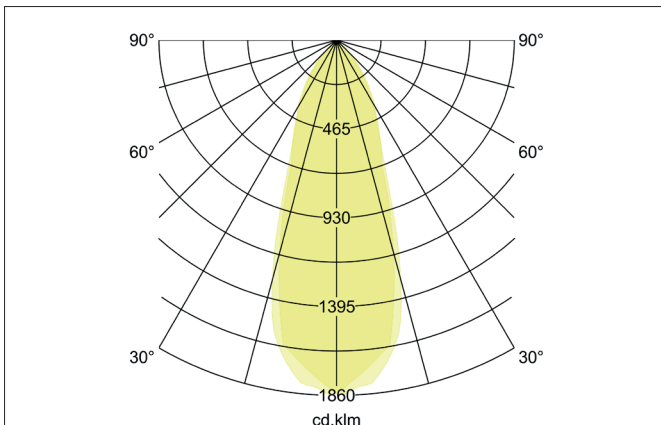
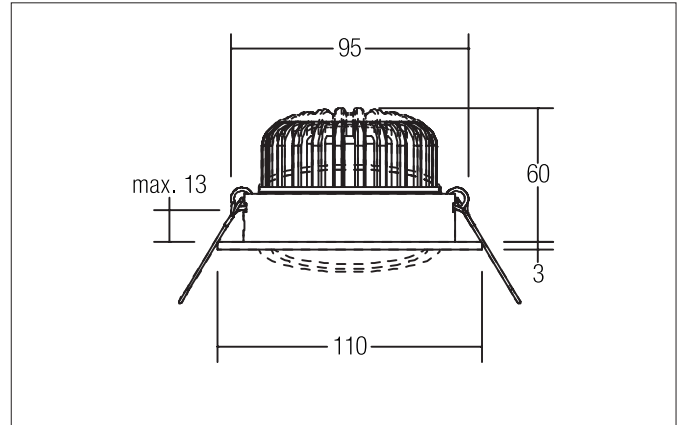

KERBY-R LED recessed spot, dim2warm

Article no. 12491073

Light.
For Generations.**Tender**

LED recessed spot, dim2warm, Round. Toolless ceiling installation by installation springs. Ceiling cut-out \varnothing 95 mm, Installation depth 60 mm, Outer diameter 110 mm, Weight 0,269 kg. Reflector silver with rotationssymmetrical, deep, wide distributed light intensity. optimal light distribution due to a glass transparent cover. Luminous flux 880 lm, Power 1 x 12 W, Light colour warm white to warm white, Correlated color temperature (CCT) 3.000 K - 1.800 K, Colour rendering index CRI > 80, Rated life time L80/B20 at 25 °C: 50.000 h, Housing material: Aluminium / Glass, Colour: White, Permissible ambient temperature (ta): -20 °C - +25 °C, Protection class (EN 61140): III, Degree of protection (DIN EN 60529): IP20, .For connection to an external driver, which is not included in the scope of delivery of the luminaire. Depending on driver dimmable.

Product Benefits

- Round recessed spotlight made of solid aluminum with glass cover.
- Easy and tool-free mounting.
- CRI > 80.
- Low installation depth of 60 mm, diameter of 110 mm, Ceiling cutout 95 mm.
- Ceiling thickness maximum 13 mm.
- Version dim2warm for current supply with 350 mA.
- Alternatively as a set dimmable (trailing-edge phase dimmer), in version 350 mA with static color temperature and in construction form square available.

KERBY-R LED recessed spot, dim2warm

Article no. 12491073

Light.
For Generations.

Article data	
Article no.	12491073
GTIN	4251433914426
Series name	KERBY-R
Short description	LED recessed spot, dim2warm
Material	Aluminium / Glass
Colour	White
Type of surface	Matt
Shape	Round
Outer diameter	110 mm
Built-in diameter	95 mm
Installation depth	60 mm
Hight	3 mm
Weight	0.269 kg

Lighting technology	
Colour temperature	3.000 K - 1.800 K
Light colour	White
Light output	Direct
Luminous flux	880 lm
System efficiency	73 lm/W
Colour rendering	CRI > 80
Reflector	High-gloss
Reflektorfarbe	silver
Beam angle	38°
Light sharing	Symmetric

Operating technology of the luminaire	
Voltage type	DC
Current	350 mA
Lamp	LED
Protection class	III
Degree of protection	IP20
Dimmable	Depending on type of control gear
Control	Depending on driver
Bulb change possible	The light source of this luminaire may only be replaced by the manufacturer or a service technician commissioned by him or a similarly qualified person.
Rated life time L80/B20 at 25 °C	50.000 h

Mounting technology	
Mounting method	Recessed mounting
Place of installation	Ceiling-mounted
Adjustability	Pivoted
Swivel angle	15°
Max. ceiling thickness	13 mm
Further references	No mounting box No cover with thermal insulation material
Material cover	Glass transparent
Suitable for through-wiring	Yes, with optional accessories

KERBY-R LED recessed spot, dim2warm

Article no. 12491073

Light.
For Generations.

Packing data	
Gross weight	0.31 kg
Length of packaging	110 mm
Packaging width	65 mm
Packaging height	120 mm
Disposal at end of life	<p>This product must not be disposed of with household waste. You are obliged, to dispose of such electrical waste separately.</p> <p>By disposing of electrical waste and other old or defective electronics separately, you support recycling or other forms of re-use. In that way you help to take care and to avoid that harmful substances get into the environment.</p>

KERBY-R LED recessed spot, dim2warm

Article no. 12491073









Light.
For Generations.

Accessories	
	Article no.: 17664000 LED converter 350 mA, trailing-edge phase dimmable Power: 10,2 - 14 W Dimensions: 125 mm x 51 mm x 20 mm
	Article no.: 17664010 LED converter 350 mA, trailing-edge phase dimmable Power: 10,2 - 14 W Dimensions: 125 mm x 51 mm x 20 mm
	Article no.: 17664020 LED converter 350 mA, trailing-edge phase dimmable Power: 10,2 - 14 W Dimensions: 125 mm x 51 mm x 20 mm
	Article no.: 17643000 LED converter 350 mA, trailing-edge phase dimmable Power: 8,8 - 18 W Dimensions: 110 mm x 52 mm x 22 mm
	Article no.: 17643010 LED converter 350 mA, trailing-edge phase dimmable Power: 8,8 - 18 W Dimensions: 110 mm x 52 mm x 22 mm
	Article no.: 17643020 LED converter 350 mA, trailing-edge phase dimmable Power: 8,8 - 18 W Dimensions: 110 mm x 52 mm x 22 mm
	Article no.: 17657000 LED converter 350 mA, 1-10 V dimmable (analog) Power: 5,2 - 18 W Dimensions: 110 mm x 52 mm x 22 mm
	Article no.: 17657010 LED converter 350 mA, 1-10 V dimmable (analog) Power: 5,2 - 18 W Dimensions: 110 mm x 52 mm x 22 mm
	Article no.: 17683000 LED converter 350 mA, DALI dimmable (digital) Power: 3,5 - 17 W Dimensions: 110 mm x 52 mm x 22 mm
	Article no.: 17683010 LED converter 350 mA, DALI dimmable (digital) Power: 3,5 - 17 W Dimensions: 110 mm x 52 mm x 22 mm

KERBY-R LED recessed spot, dim2warm

Article no. 12491073



Light.
For Generations.

Accessories	
	Article no.: 17683020 LED converter 350 mA, DALI dimmable (digital) Power: 3,5 - 17 W Dimensions: 110 mm x 52 mm x 22 mm
	Article no.: 17671000 LED converter 350mA, ZigBee dimmable Power: 3,5 - 18,5 W Dimensions: 146 mm x 44 mm x 30 mm
	Article no.: 17671010 LED converter 350mA, ZigBee dimmable Power: 3,5 - 18,5 W Dimensions: 146 mm x 44 mm x 30 mm
	Article no.: 17671020 LED converter 350mA, ZigBee dimmable Power: 3,5 - 18,5 W Dimensions: 146 mm x 44 mm x 30 mm
	Article no.: 17672000 LED converter 350mA, Casambi dimmable Power: 3,5 - 18 W Dimensions: 146 mm x 44 mm x 30 mm
	Article no.: 17672010 LED converter 350mA, Casambi dimmable Power: 3,5 - 18 W Dimensions: 146 mm x 44 mm x 30 mm
	Article no.: 17672020 LED converter 350mA, Casambi dimmable Power: 3,5 - 18 W Dimensions: 146 mm x 44 mm x 30 mm
	Article no.: 17682000 LED converter 350 mA, DALI dimmable (digital) : 1,8 - 18,5 W Dimensions: 146 mm x 43.5 mm x 22 mm
	Article no.: 17682010 LED converter 350 mA, DALI dimmable (digital) : 1,8 - 18,5 W Dimensions: 146 mm x 43.5 mm x 22 mm
	Article no.: 17682020 LED converter 350 mA, DALI dimmable (digital) : 1,8 - 18,5 W Dimensions: 146 mm x 43.5 mm x 22 mm
	Article no.: 3835 Plug & Play extension lead 350 mA Dimensions: 500 mm

KERBY-R LED recessed spot, dim2warm

Article no. 12491073

Light.
For Generations.

Accessories	
	<p>Article no.: 3836 Plug & Play extension lead 350 mA</p> <p>Dimensions: 1,000 mm</p>
	<p>Article no.: 3837 Plug & Play extension lead 350 mA</p> <p>Dimensions: 2,000 mm</p>