

Datablad

Art. Nr. 96.030.0253.1

fordeler RST20I3V 3P1 V SW

RST20I3 3-pol Fordelerblok 250V/20A 1I/3O IP68 sort



Art. Nr.	96.030.0253.1
EAN	4015573735255
Ordre enhed	100 styk

Godkendelser

Specifikationer
Generelt

Nominal strøm	20 A
Nominal spænding	250 V
Nominal impuls spænding	4 kV
Forureningsgrad	3
låsbar	
Farve på kodning/kontaktindsats	Sort
Pol mærkning	L, N, PE

Model

Antal af indgange	1
Antal af udgange	3
Type fastgørelse	nej
Tæthedsklasse (IP)	IP66/68 (3m;2h) /IP69
fordeler type	fordelerblok

Materiale

Materiale kasse	Polyamid
Halogenfri	ja
Kontakt material	CuZn
brand belastning	0,224 kWh
Kontinuerlig temperatur, isolationsdele	100 °C
Overfladebehandling	forsølvet

Dimensioner

Længde	55,5 mm
Bredde	69,6 mm
Højde	31,3 mm

Tilbehør

Art. Nr.	Type	Beskrivelse
----------	------	-------------

05.564.4453.1	Blindprop for hanstik SW	RST20i3/2 blindprop, for afblinding af ubenyttet han stik, sort
99.414.6205.2	Blindprop for hunstik SW	RST20i3/2 blindprop, for afblinding af ubenyttet hun stik, med snor, color schwarz
99.416.6205.2	Blindprop for hanstik SW	RST20i3/2 blindprop, for afblinding af ubenyttet han stik, med snor, sor
Z5.564.4553.1	Blindprop for hunstik SW	RST20i3/2 blindprop, for afblinding af ubenyttet hun stik, sort

drawn construction: 96.030.0153.0
 Gezeichnete Ausführung: 96.030.0153.0

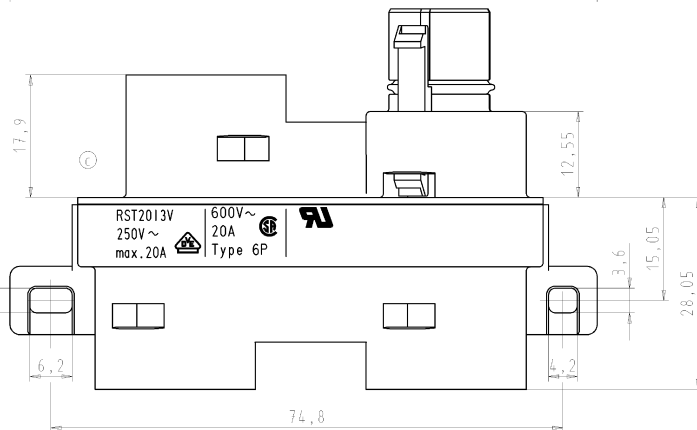
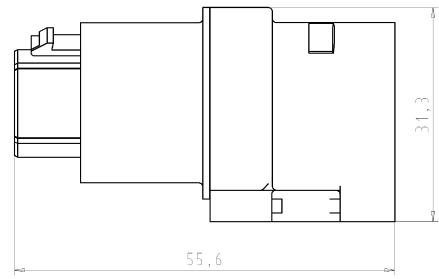
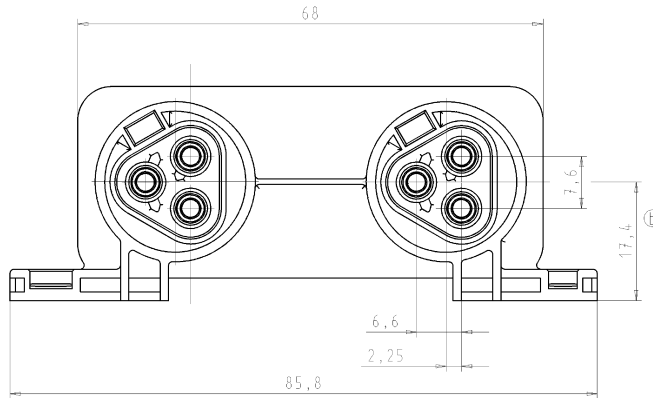

180°

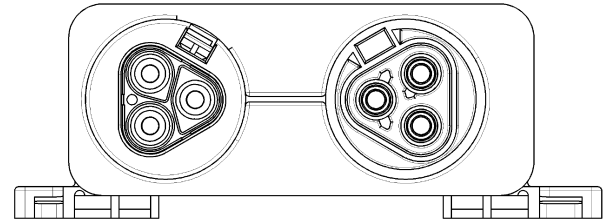

scale 1:1
 Maßstab 1:1

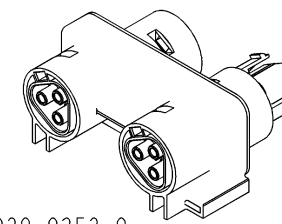
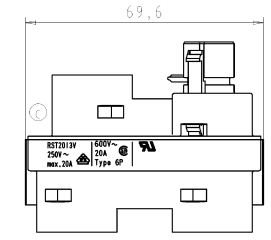

drawn construction: 96.030.0253.0
 Ausführung: 96.030.0253.0

scale 1:1
 Maßstab 1:1

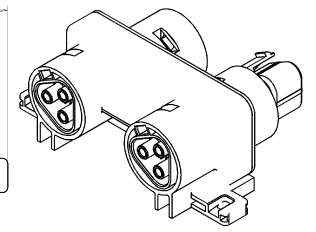
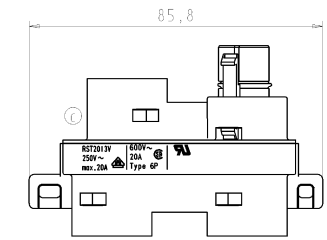

drawn construction: 96.030.0153.0
 Ausführung: 96.030.0153.0

packaging unit: per 100
 Verpackungseinheit: je 100 Stk.

Teile-Nr.	Type	Farbe	Variante
96.030.0153.1	RST2013V_3P1_F_V_SW	schwarz, ähnl. RAL 9005	mit Anschraubflansch
		black, similar to RAL 9005	with screwing flange
96.030.0153.0	RST2013V_3P1_F_V_GL	grau, ähnl. RAL 7032	mit Anschraubflansch
		grey, similar to RAL 7032	with screwing flange
96.030.0253.1	RST2013V_3P1_V_SW	schwarz, ähnl. RAL 9005	ohne Anschraubflansch
		black, similar to RAL 9005	without screwing flange
96.030.0253.0	RST2013V_3P1_V_GL	grau, ähnl. RAL 7032	ohne Anschraubflansch
		grey, similar to RAL 7032	without screwing flange

Erstellung nach: ... Maßstab: 2:1 ...

2003 Tag: ... Name: ...

Erstverf. 23.10. Kreis: ...

Gepr. ...

Erstz. für: ...

wieland
 Elektroische
 Verbindungen

Bezeichnung: VERTEILER
 DISTRIBUTION BLOCK
 für: RST2013/for: RST2013

A
1
2
3
4
5
6
7
8
9
10
11
12
13
14
15
16
17
18
19
20
M1
M2
M3
L
G
I
1.1
2.1
1.1