

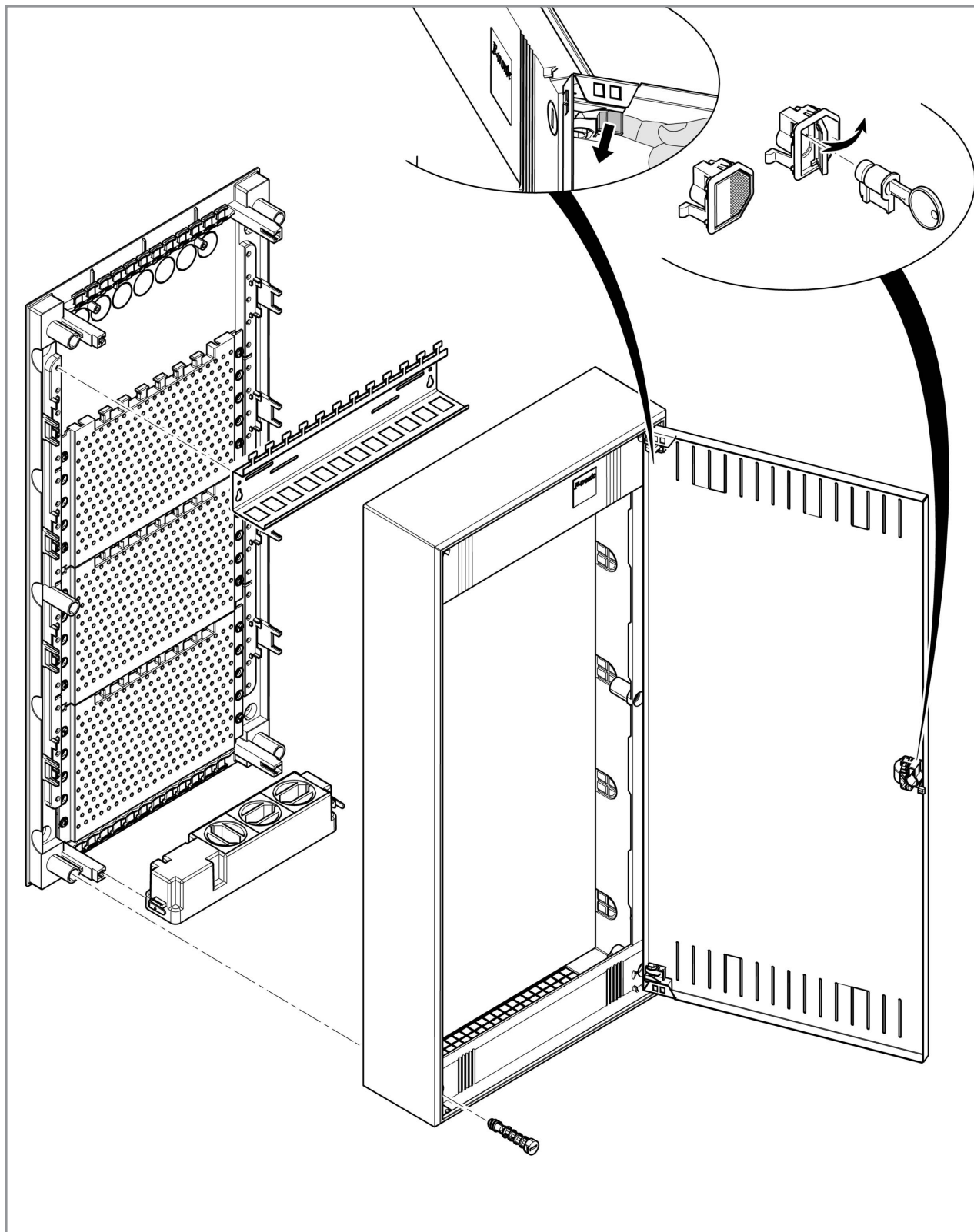

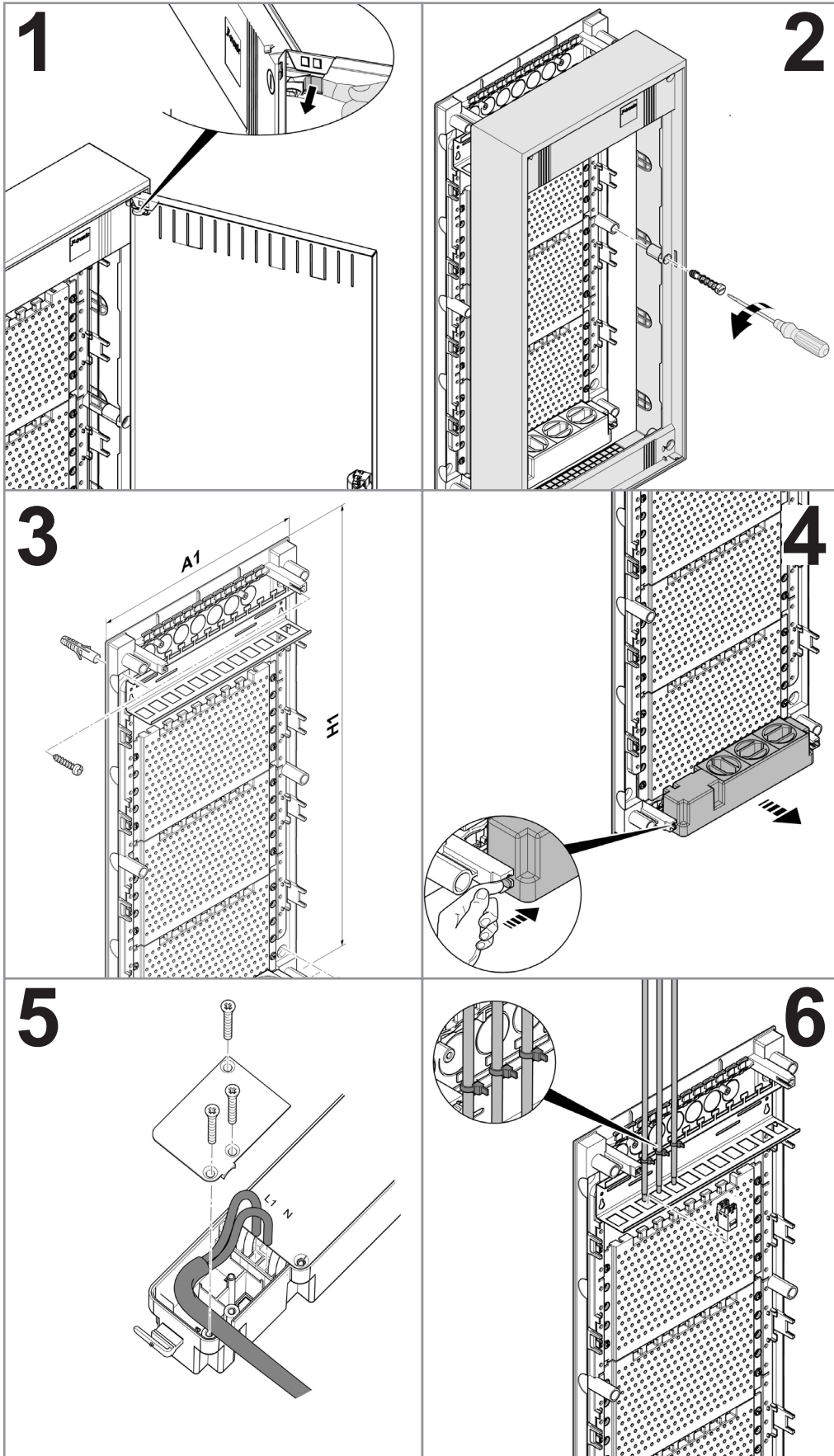

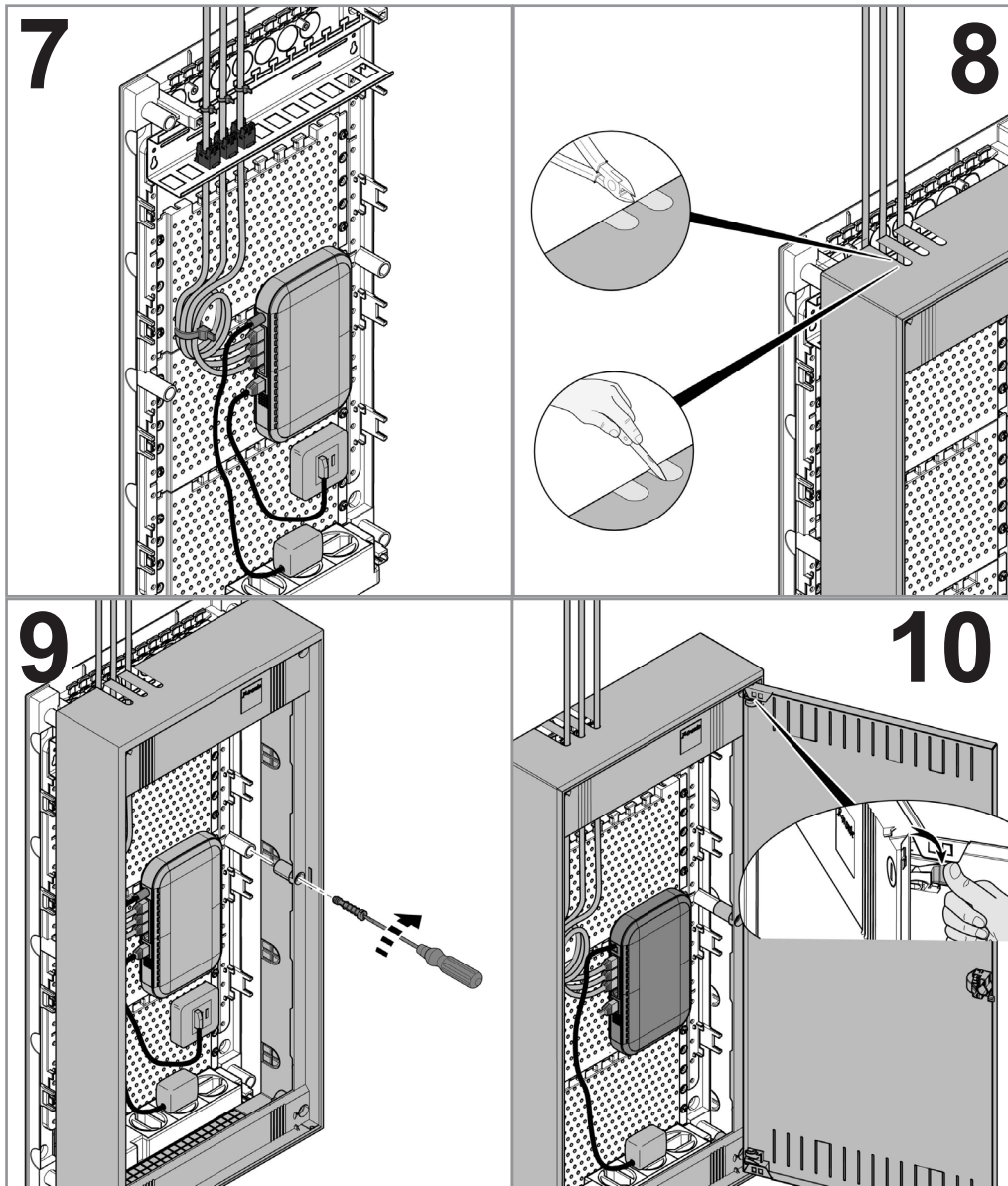





Montageanleitung / Assembly Instructions Vision K

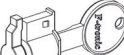

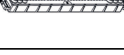
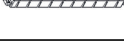

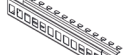
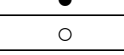

Typ	Höhe	Breite	Tiefe
APV 12+2	250	305	99
APV 24+4	375	305	99
APV 36+6 u. APV36K	515	305	99
APV 48+8 u. APV48K	640	305	99

Bild	Typ	Art. Nr.	Aufputzverteiler VISION mit Steckklemmen / Wall-mounted distributors Vision with plug clamp				Aufputzverteiler VISION mit Schraubklemmen / Wall-mounted distributors Vision with screw clamps				Kommunikationsverteiler VisionK / Communication distributors Vision K	
			1 reihig / 1-row / 12+2	2 reihig / 2-row / 24+4	3 reihig / 3-row / 36+6	4 reihig / 4-row / 48+8	1 reihig / 1-row / 12+2PEN	2 reihig / 2-row / 24+4PEN	3 reihig / 3-row / 36+6PEN	4 reihig / 4-row / 48+8PEN	3 reihig / 3-row	4 reihig / 4-row
	ADS12	7290032	○	○	○	○	○	○	○	○	—	—
	TSV	7220086	○	○	○	○	○	○	○	○	—	—
	SKN17N	9910009	○	○	●	●	○	○	○	○	—	—
	SKN17PE	9910010	●	●	○	○	○	○	○	○	—	—
	SKN34	9910011	○	○	●	●	○	○	○	○	—	—
	SKPE34	9910012	○	○	●	●	○	○	○	○	—	—
	PEN143-2	7290084	○	○	○	○	●	●	○	○	—	—
	PE286-1	7290083	○	○	○	○	○	○	●	●	—	—
	N286-1	7290081	○	○	○	○	○	○	●	●	—	—
	NN143-2	7290082	○	○	○	○	○	○	○	○	—	—
	160030	7290002	●	●	○	○	○	○	○	○	—	—
	STECKD3	7290113	○	○	○	○	○	○	○	○	●	●
	PATCH12	7290116	○	○	○	○	○	○	○	○	●	●
●	Serienausstattung / Standard equipment											
○	Zubehör / Accessories											
—	nicht kompatibel / not compatible											