

JAMIE 301.930.25.2/DALI-EU



Beschreibung

- flexibler Stromschienenstrahler in kompakter Bauform mit zylinderförmigem Design
- Leuchte 350° drehbar und 90° schwenkbar über integrierten Gelenkarm
- hohe Wartungsfreundlichkeit
- keine UV- und Wärmestrahlung
- Wärmemanagement über Gehäuse
- Spiegelreflektor aus Aluminium mit präziser symmetrischer Abstrahlcharakteristik für optimale Lichtausbeute und Entblendung
- Gehäusezylinder aus Aluminium
- Schutzglas klar
- 3-Phasen-Stromschienenadapter DALI (Professional)
- Betriebsgerät (LED-Konverter DALI, dimmbar) integriert

Standardoptionen

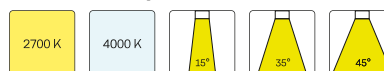

Farbe	Artikelnummer	EAN
schwarz	657971	4043544668899
silber	657972	4043544668905
weiß	657973	4043544668912

Sonderoptionen



Lichttechnik / Normen

Leuchtmittel	LED Spot / CRI 90 / 3000 K
EPREL Lichtquellen	851023
Lebensdauer	L90 B50 50.000 h L80 B50 100.000 h L80 B20 50.000 h
Systemleistung	16.0 W
Leuchten-Lichtstrom	1390 lm
Systemeffizienz	86.87 lm/W
Moduleffizienz	132.78 lm/W
UGR Klasse	≤19
Abstrahlwinkel	25°
Versorgungsspannung	220 - 240 V / 50 - 60 Hz
Schutzklasse	I
Schutzart	IP20

Abmessungen / Gewichte

Länge	125 mm
Breite	80 mm
Höhe	215 mm
Durchmesser Lichtkopf	80 mm
Nettogewicht	0.90 kg
Bruttogewicht	1.00 kg

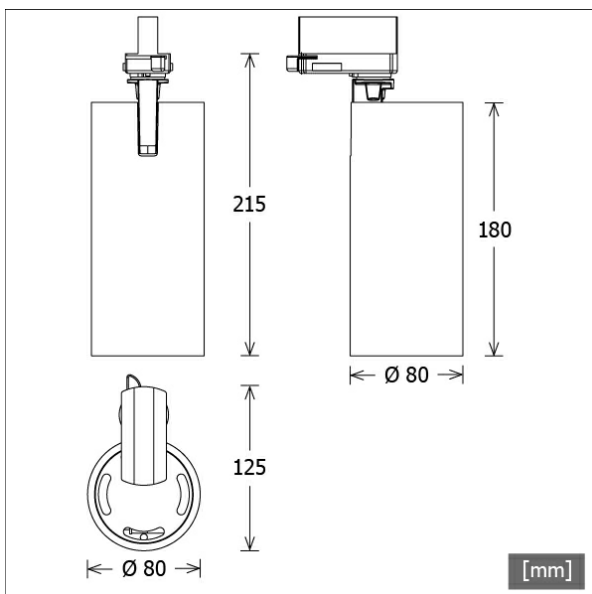

JAMIE 301.930.25.2/DALI-EU

Jamie 300 (1xLED 16W 930/3000K 1390lm 25 °)

C0/C180 cd / 1000 lm

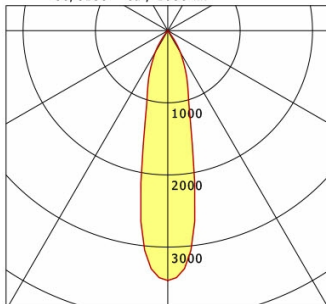

	C0	C90	C180	C270
0°	3464	3464	3464	3464
15°	1160	1160	1160	1160
30°	351	351	351	351
45°	17	17	17	17
60°	9	9	9	9
75°	5	5	5	5
90°	0	0	0	0
cd / 1000 lm				

Offset [m] Cone width [m] Illuminance [lx]

Offset [m]	Cone width [m]	Illuminance [lx]
3.0	1.24	535.0
6.0	2.48	133.8
9.0	3.73	59.4
12.0	4.97	33.4
15.0	6.21	21.4

η	LED
Efficiency	87 lm/W
Direct/Indirect	↓ 100% / ↑ 0%
System Power	16 W
UGR	X=4H, Y=8H
Reflection factors	70/50/20
UGR C0/C180	17.7
UGR C90/C270	17.7
CIE Flux Codes	96 99 100 100 100
Ra/CRI	>90

LTS

Zubehör



EUB 10
Anbau-Stromschiene Professional mit Datenbus
(Länge: 1000 mm)



EUB 20
Anbau-Stromschiene Professional mit Datenbus
(Länge: 2000 mm)



EUB 21
Anbau-Stromschiene Professional mit Datenbus
(Länge: 3000 mm)



EUB 22
Anbau-Stromschiene Professional mit Datenbus
(Länge: 4000 mm)



EUEB 20
Einbau-Stromschiene Professional mit Datenbus
(Länge: 2000 mm)



EUEB 21
Einbau-Stromschiene Professional mit Datenbus
(Länge: 3000 mm)



EUEB 22
Einbau-Stromschiene Professional mit Datenbus
(Länge: 4000 mm)



LAB 60
3-Phasen-Einbau-Monopoint mit Busoption



LAB 60 A
3-Phasen-Anbau-Monopoint mit Busoption



ZBK 12
Blendklappe



ZBW 85
Wabenraster