

ANNA LED PANEL



EN	Installation Instructions	IT	Istruzioni di montaggio
DE	Montageanleitung	LT	Montavimo Instrukcijos
CZ	Montážní návod	LV	Instalācijas instrukcija
DK	Monteringsvejledning	NO	Monteringsanvisning
EE	Paigaldusjuhend	PL	Instrukcja montażu
FI	Asennusohje	SE	Installationsanvisning
FR	Notice de montage	RU	Инструкция по монтажу
HU	Szerelési útmutató	SRB	Instrukcija za instalaciju
HR	Uputstvo za montažu	SK	Montážny návod
NL	Montagehandleiding	SLO	Navodilo za montažo
RO	Instructiuni de montaj	CN	安装说明书

- ! 1. Installation and commissioning may only be carried out by authorized specialists and wired in accordance with the latest IEE electrical regulations or the national standards.
 - ⚡ 2. Mains power must be switched off before carrying out installation.
 - 3. The manufacturer, shall not be liable for any damage resulting from inappropriate modifications to the luminaire or faulty installation.
 - 4. Indoor use only.
 - 5. Caution, risk of electric shock.
- The control gear provides basic insulation between the LV supply and the control circuit.



Zumtobel LIGHTING GmbH
 Schweizer Strasse 30
 A-6851 Dornbirn AUSTRIA
 URL: www.thorn-eco.com

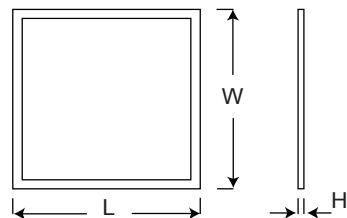

SAP Code	Product Description	Input	PF	Wattage	Operating temperature	Dimension LxWxH(mm)	Safety wire
96631113	ANNA LED Q596 3500 840 HFIX	AC220-240V 50/60Hz	0.9	33W	-20~40°C	596x596x8.5	✓
96631114	ANNA LED Q622 3500 840 HFIX	AC220-240V 50/60Hz	0.9	33W	-20~40°C	622x622x8.5	×
96631115	ANNA LED Q596 3500 840 HFIX E3	AC220-240V 50/60Hz	0.9	33W	+5~+25°C	596x596x8.5	×
96631116	ANNA LED Q596 3200 830 HFIX	AC220-240V 50/60Hz	0.9	33W	-20~40°C	596x596x8.5	✓
96631117	ANNA LED Q622 3200 830 HFIX	AC220-240V 50/60Hz	0.9	33W	-20~40°C	622x622x8.5	×
96631118	ANNA LED Q596 3500 840 HFIX TpA	AC220-240V 50/60Hz	0.9	33W	-20~40°C	596x596x8.5	×
96631119	ANNA LED Q596 3500 840 HFIX TpA E3	AC220-240V 50/60Hz	0.9	33W	+5~+25°C	596x596x8.5	×
96630223	ANNA Suspension Kit	×	×	×	×	L1500	×

Safety Wire Installation Manual

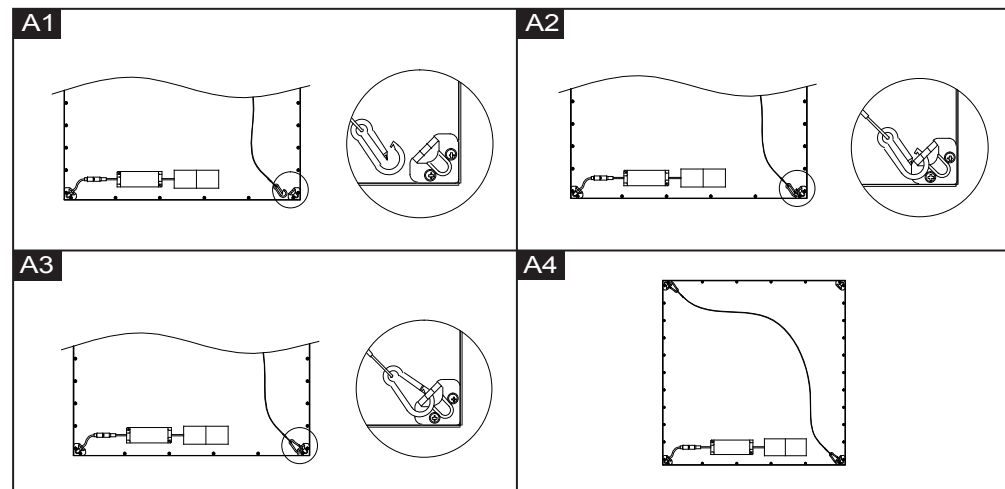

Suspension Kit User Manual

96630223 ANNA Suspension Kit

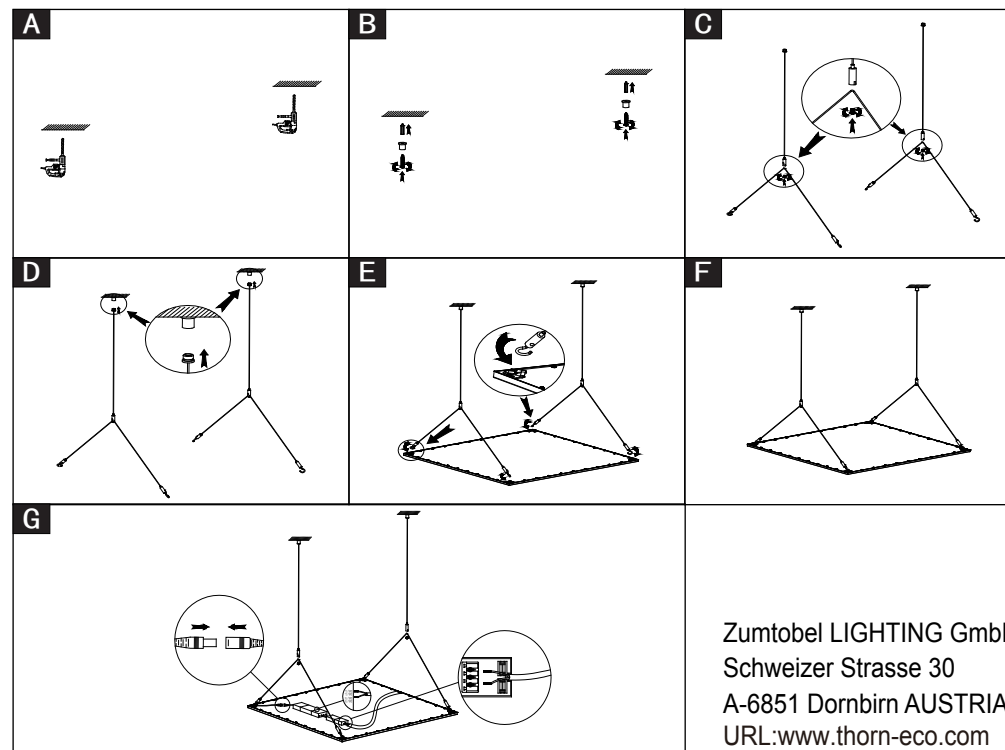

Zumtobel LIGHTING GmbH
 Schweizer Strasse 30
 A-6851 Dornbirn AUSTRIA
 URL: www.thorn-eco.com

ANNA LED PANEL

Recessed mount

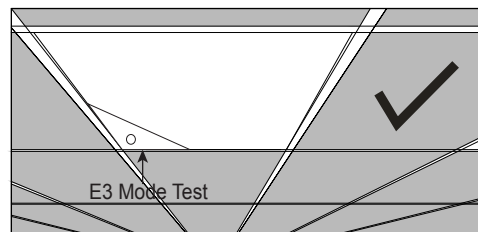
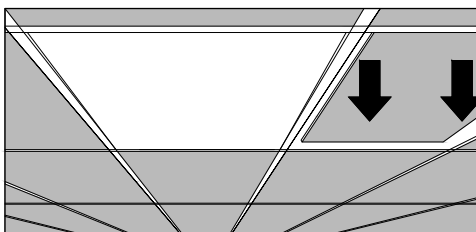
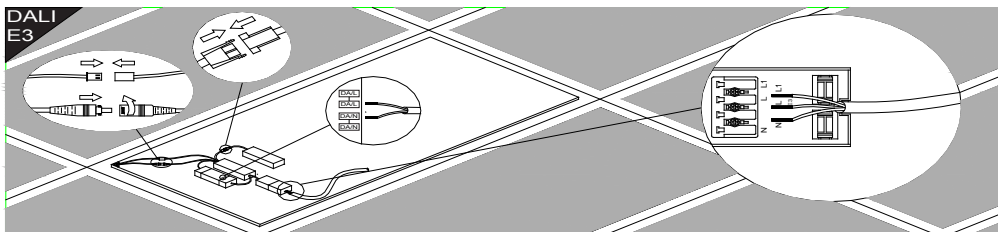
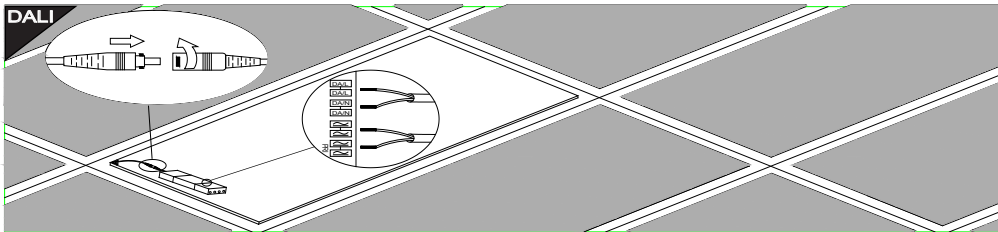
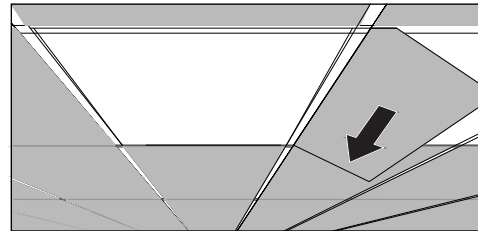
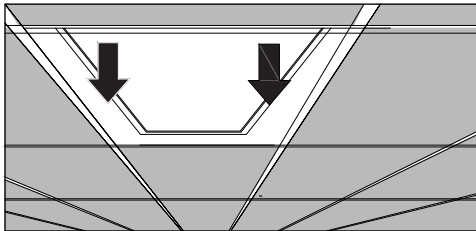
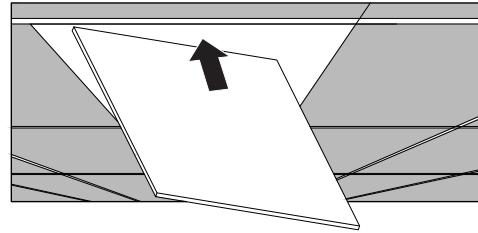
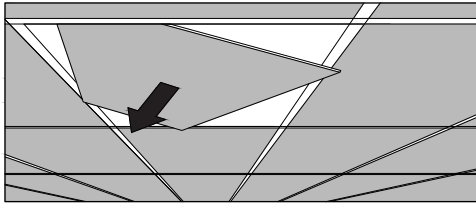

ANNA LED PANEL

(DE) Hinweise für die Montage und den Betrieb!

Die Montage und Inbetriebnahme der Leuchte sowie jede Veränderung an der Leuchte darf nur von autorisierten Fachkräften (qualifizierter Elektriker) durchgeführt werden. Die nationalen Errichterbestimmungen sind zu beachten. Vor jeder Arbeit an der Leuchte ist diese vom Netz zu trennen. **Hot Plug-In ist nicht möglich und kann zu Schäden an der Leuchte führen!**

Der Hersteller haftet nicht für Schäden, die aus fehlerhafter Montage, aus unsachgemäßem Betrieb oder unautorisierten Veränderungen an der Leuchte resultieren.

Die Lichtquelle dieser Leuchte darf nur vom Hersteller oder einem von ihm beauftragten Servicetechniker oder einer vergleichbar qualifizierten Person ausgetauscht werden.

Vorsicht, Gefahr eines elektrischen Schlags.

Technische Änderungen vorbehalten! Bei Fragen wenden sie sich an den Hersteller.

(EN) Instructions for installation and operation!

The installation and commissioning of the luminaire as well as any modification to the luminaire may only be performed by authorized personnel (qualified electrician). National installation regulations must be observed. Before any work on the appliance is done, it must be disconnected from mains.

Hot plug-in is not an option and may cause damage to the lamp or luminaire!

The manufacturer is not liable for damages resulting from improper or faulty installation or operation or from unauthorized modifications to the luminaire.

The light source contained in this luminaire shall only be replaced by the manufacturer or his service agent or a similarly qualified person.

Caution, risk of electric shock!

Specifications are subject to change without notice! If you have questions, please contact the manufacturer.

(FR) Instructions pour l'installation et l'utilisation!

L'installation et la mise en service du luminaire ainsi que toute modification au luminaire doivent être effectuées par un personnel autorisé (électricien qualifié). Les règles nationales d'installation doivent être respectées. Avant toute intervention sur l'appareil, il doit être débranché de son alimentation.

Le branchement à chaud est interdit, et peut endommager à la lampe ou le luminaire!

Le fabricant décline toute responsabilité pour les dommages résultant d'une mauvaise installation ou opération, ou d'une modification non autorisée du luminaire.

La source lumineuse présente dans le luminaire ne peut être remplacée que par le fabricant, par son service technique ou une personne qualifiée.

Avertissement, risque de choc électrique.

Sous réserve de modifications des spécifications techniques! Pour toute question contactez le fabricant

(IT) Istruzioni per l'installazione e il funzionamento!

L'installazione e la messa in servizio degli apparecchi, nonché qualsiasi modifica dell'apparecchio può essere eseguita solo da personale autorizzato (elettricista qualificato). Le norme nazionali di installazione devono essere rispettate. Prima di qualsiasi intervento sull'apparecchio, questo deve essere scollegato dalla rete.

Non è possibile un Hot Plug In e può causare danni alla lampada o all'apparecchio!

Il produttore non si assume alcuna responsabilità per i danni derivanti da un'installazione impropria o difettosa, o per modifiche non autorizzate apportate all'apparecchio.

La sorgente luminosa contenuta in questo apparecchio può essere sostituita solo dal produttore o da un centro assistenza autorizzato o da una persona qualificata.

Attenzione, rischio di folgorazione! Modifiche tecniche sono soggette a cambiamenti senza preavviso! Se avete domande si prega di contattare il produttore

(NL) Aanwijzingen voor installatie en bediening!

De installatie en inbedrijfstelling van het armatuur, alsook elke wijziging in of aan het armatuur mag alleen door bevoegd personeel (elektricien) worden uitgevoerd. De nationale installatie voorschriften moeten worden nageleefd. Voor alle werkzaamheden aan het apparaat, moet deze worden losgekoppeld van het net.

Hot plug-in is niet mogelijk en kan schade aan de lamp veroorzaken!

De fabrikant is niet aansprakelijk voor schade als gevolg van onjuiste foutieve installatie, bediening of schade welke het gevolg is van niet geautoriseerde wijzigingen aan het armatuur.

De lichtbron in dit armatuur mag enkel door de fabrikant, een service agent of een gelijkwaardig gekwalificeerd person vervangen worden.

WAARSCHUWING: Gevaar voor elektrische schokken.

Technische wijzigingen voorbehouden! Als u vragen hebt, kunt u contact opnemen met de fabrikant.

