

MAßZEICHNUNG

Dimensional drawing

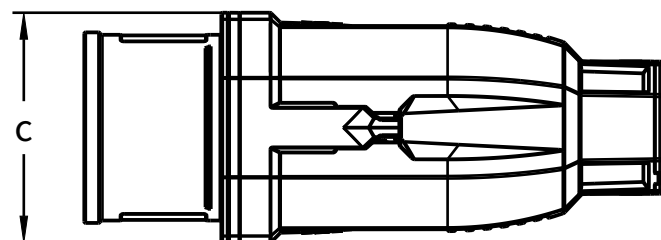
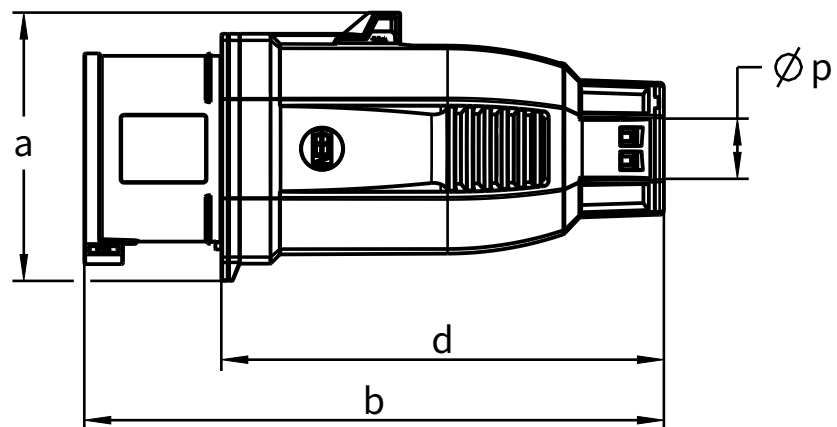

Amp.	16A		32A		
Pole	4	5	3	4	5
a	71	75	84	84	89
b	173	173	192	192	192
c	65	65	76	76	76
d	135	135	147	147	147
$\varnothing p$	7,1-15,5	8-17	9,6-18	10,7-20	11,9-22,2

SK Schraubklemme/ *screw terminal*
 SN Schraubklemme vernickelt/ *screw terminal nickel plated*
 CC Cage clamp/ *cage clamp*
 CN Cage clamp vernickelt/ *cage clamp nickel plated*
 PH Phasenwender/ *phase inverter*
 PN Phasenwender vernickelt/ *phase inverter nickel plated*