

Montageanleitung

Ⓒ mounting instruction Ⓕ Notice de montage Ⓒ Instrukcja montaży
Ⓔ Instrucciones de montaje Ⓘ Istruzioni di montaggio

RUFO2 360



RIDI Leuchten GmbH
Hauptstrasse 31 - 33 · D-72417 Jungingen
Tel. 07477/872-0 · Fax 07477/872-48
kontakt@ridi.de · www.ridi.de



- (D) Für die Installation und für den Betrieb der Leuchten sind die nationalen Sicherheitsvorschriften zu beachten.
- (GB) Please note national safety instructions for installation and operation of this luminaire.
- (F) Pour l'installation et le fonctionnement des luminaires il est impératif de respecter les normes nationales de sécurité en vigueur.
- (PL) W celu prawidłowej instalacji i poprawnego działania oprawy należy przestrzegać krajowych przepisów bezpieczeństwa.
- (E) Para la instalación y la puesta en funcionamiento de las luminarias deben observarse las normas nacionales de seguridad.
- (I) Per l'installazione e il funzionamento delle lampade si fa riferimento alle normative di sicurezza nazionali.

- (D) Die Lichtquelle dieser Leuchte darf nur vom Hersteller oder einem von ihm beauftragten Servicetechniker oder einer vergleichbar qualifizierten Person ersetzt werden.
- (GB) Only the manufacturer, a trained service technician or another equally qualified person is permitted to replace the light source of this luminaire.
- (F) La source lumineuse de ce luminaire ne peut être remplacée que par le fabricant, un technicien de service mandaté par celui-ci ou une personne présentant une qualification analogue.
- (PL) Wymiany źródła światła w tej oprawie oświetleniowej może dokonać wyłącznie producent bądź uprawniony pracownik serwisu albo osoba o podobnych kwalifikacjach.
- (E) La fuente de luz de esta luminaria solamente podrá ser sustituida por el fabricante o una persona designada por este, ya sea un técnico de servicio u otra persona debidamente cualificada.
- (I) La sorgente luminosa di tale lampada può essere sostituita solo dal produttore o da un tecnico di assistenza da questi designato oppure da personale dotato di qualifica equivalente.

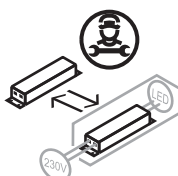
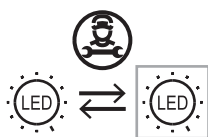

IP40

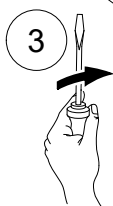
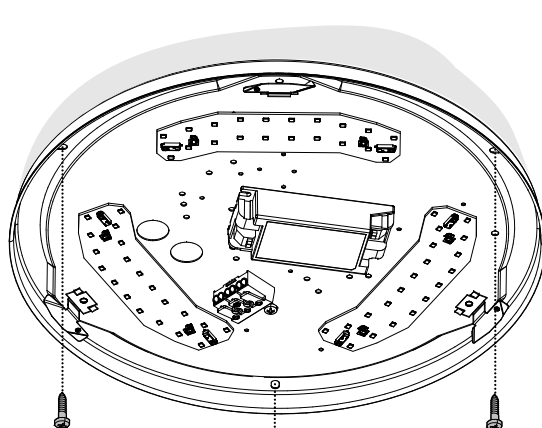
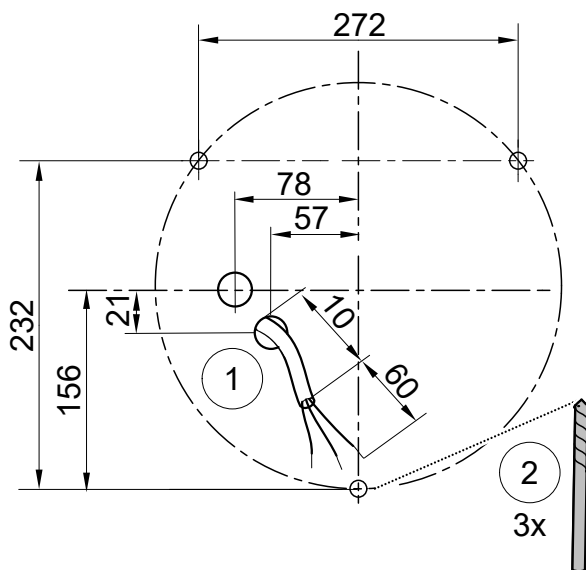

bauseits
to be supplied on-site
À prévoir sur place
we własnym zakresie
por parte del cliente
a cura del cliente

RIDI
..... V
..... Hz

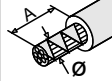
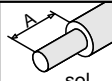

	Ø	A
	0,8-1,2	9
max. ø1,8mm	1,3-1,8	12
	mm ²	A
sol.	0,5-1,0	9
0,5-2,5mm ²	1,5-2,5	12

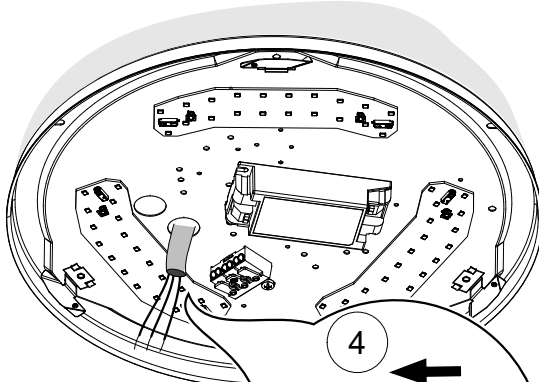
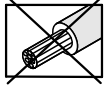

...EDS3

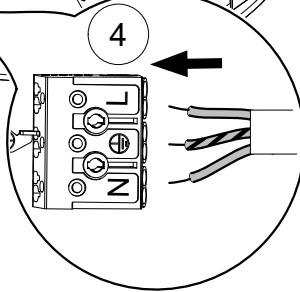
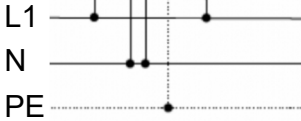
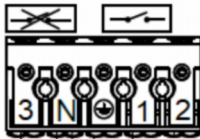

RIDI
Montageanleitung
Radarsensor
RUFO2
RUFO-ECO2

MON6772

...RS

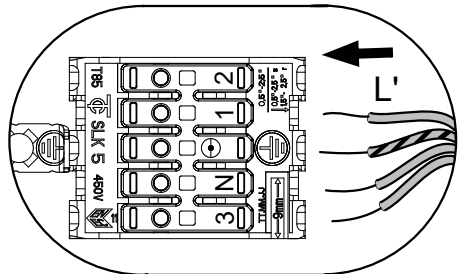
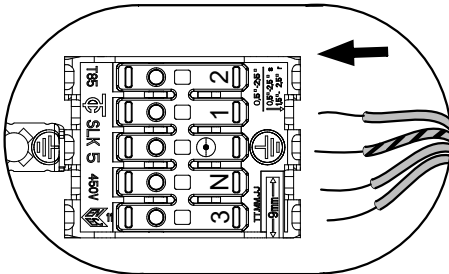

...2K

...DALI

