

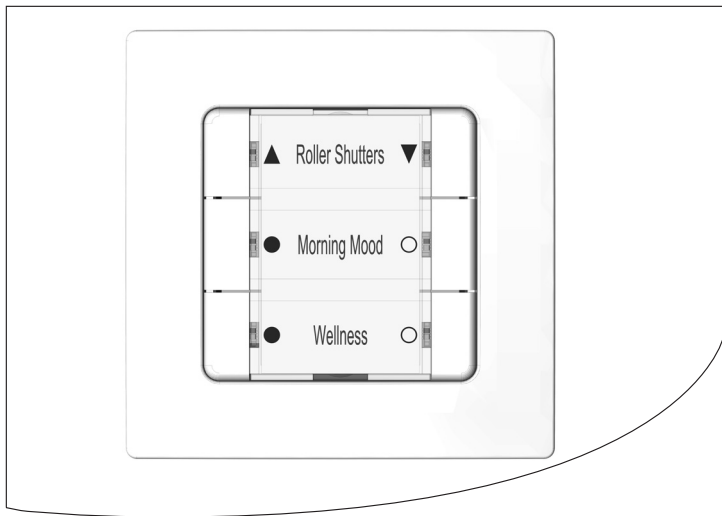

**EN DuoFern Multiple Wall Controller 9494-2**  
Instruction manual for the electrical connection and for commissioning

Item no. 3250 19 72 / Type: 9494-2 (flush-mounted device for 230 V/ 50 Hz)



With your purchase of a **DuoFern Multiple Wall Controller**, you have chosen a quality product manufactured by RADEMACHER. Thank you for the trust you have placed in us.

RADEMACHER products have been developed with the greatest possible convenience in mind. Having applied uncompromising quality standards and thorough testing, we are proud to be able to present this innovative product to you.

It's brought to you by all the highly-qualified personnel here at RADEMACHER.



<b>i</b>	<b>Dear Customer,</b> .....	<b>2</b>
<b>1.</b>	<b>This manual...</b> .....	<b>5</b>
1.1	How to use this manual .....	5
<b>2.</b>	<b>Hazard symbols</b> .....	<b>6</b>
2.1	Levels of danger and signal words.....	6
2.2	Symbols and depictions used.....	7
2.3	Glossary - definition .....	7
<b>3.</b>	<b>Included in delivery</b> .....	<b>8</b>
<b>4.</b>	<b>Front view of the operating unit</b> .....	<b>9</b>
<b>5.</b>	<b>Product description</b> .....	<b>10</b>
5.1	Button functions.....	12
5.2	Button combinations .....	13
<b>6.</b>	<b>Technical specifications</b> .....	<b>14</b>
6.1	Conduct in the event of a power failure .....	16
<b>7.</b>	<b>Safety instructions</b> .....	<b>17</b>
7.1	Intended use .....	18
7.2	Improper use.....	19
7.3	Required expert knowledge of the installer.....	19
<b>8.</b>	<b>Installation</b> .....	<b>20</b>
8.1	Printing the label insert.....	20
8.2	Selecting the suitable installation location .....	22
8.3	Connecting the DuoFern Multiple Wall Controller 9494-2.....	22
8.4	Safety instructions for the electrical connection .....	23
8.5	Carrying out the Electrical Connection .....	24
8.6	Connection of a lamp and push button.....	25
8.7	Connection Diagram with Changeover Switch.....	26
8.8	Installation after the electrical connection .....	27

<b>9. Commissioning .....</b>	<b>28</b>
9.1 Removing the factory default reservation for buttons 1 and 2 .....	29
9.2 Logging on DuoFern Devices .....	30
9.3 Logging off DuoFern devices.....	32
9.4 Logging on to the HomePilot® .....	33
9.5 Clearing up the DuoFern network .....	35
<b>10. Activating the jog mode .....</b>	<b>36</b>
10.1 Operation in jog mode.....	37
<b>11. Setting the lighting.....</b>	<b>38</b>
<b>12. Changing the direction of rotation.....</b>	<b>39</b>
<b>13. Carrying out a hardware reset, e.g. if a unit fails.....</b>	<b>40</b>
<b>14. Erase all settings, software reset .....</b>	<b>41</b>
<b>15. Dismantling .....</b>	<b>42</b>
<b>16. Simplified EU Declaration of Conformity.....</b>	<b>43</b>
<b>17. Warranty Terms and Conditions .....</b>	<b>44</b>
<b>18. Cut out label insert.....</b>	<b>45</b>



## 1. This manual...

EN

...describes the electrical connection, installation, commissioning and operation of your DuoFern Multiple Wall Controller 9494-2.



### 1.1 How to use this manual

- ◆ Before you begin, please read this manual through completely and follow all the safety instructions.
- ◆ Please also read the instruction manuals of the logged on DuoFern devices as well as of the respective connected appliance.
- ◆ This manual is part of the product. Please store it in an easily accessible place.
- ◆ When passing the DuoFern Multiple Wall Controller on to a third party, this manual must be passed on as well.
- ◆ Damage resulting from non-compliance with these instructions and safety instructions will void the warranty. We assume no liability for any consequential damage.



## 2. Hazard symbols

EN

The following hazard symbols are used in this instruction manual:



**Danger of fatal electric shock**



**Danger area / dangerous situation**



### 2.1 Levels of danger and signal words



**DANGER!**

This hazard will lead to serious injury or death if not avoided.



**WARNING!**

This hazard may result in serious injury or death if not avoided.





**CAUTION!**

This hazard may result in minor or moderate injury if not avoided.



**ATTENTION!**

This hazard may lead to property damage.

Depiction	Description
1.	Procedures
2.	
◆	Itemisation
1) or a)	Lists
	further useful information
	Please read the respective manual.

**DuoFern**

- ◆ RADEMACHER radio technology for controlling compatible products.

**HomePilot®**

- ◆ The HomePilot® is a central controller unit for RADEMACHER radio products.

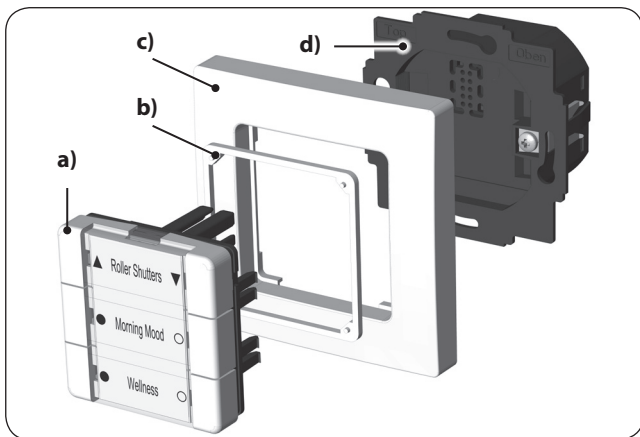

- a) 1 x Operating unit (50 x 50 mm) with removable cover panel for the label insert
- b) 1 x Spacer frame
- c) 1 x Frame
- d) 1 x Installation housing
- Not illustrated**
- e) 1 x Label insert, see page 20.
- f) 1 x Instruction manual

**After unpacking please check and compare...**

... the contents of the package with those specified above.

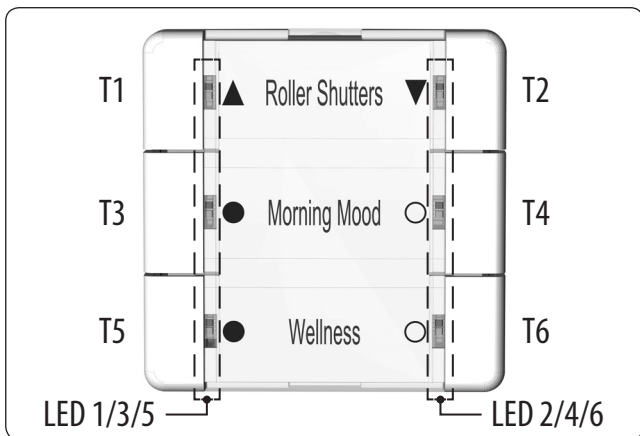

**Symbol****Description**

T1 to T6

Buttons 1 to 6

LED 1 to LED 6

Each button has a red/white LED

### Function

---

The DuoFern Multiple Wall Controller serves to log on and control various DuoFern devices. The six operating buttons can be used to transmit the desired commands to the logged on DuoFern devices. Six two-tone LEDs (red/white) provide information on the respective status of the operation.

### Max. number of DuoFern devices

---

A maximum of 8 DuoFern devices can be logged on per button group. When logging on, the individual DuoFern devices are automatically detected and recognised by the DuoFern Multiple Wall Controller.

### Jog mode

---

To control Venetian blinds with slats, the DuoFern Multiple Wall Controller can be switched to jog mode.

### White LEDs used to display the status and for lighting

---

The white LEDs of the DuoFern Multiple Wall Controller can additionally be used to display the status as well as for lighting. If required, the brightness of the white LEDs can also be adjusted with three different settings.

### Relay output [ L' ] and external control input [ Ext. ]

---

In addition, the DuoFern Multiple Wall Controller 9494-2 is equipped with







- ◆ a relay output [ L' ] for the connection \* of an electrical appliance: e.g. lighting when replacing a light switch.
- ◆ an external control input [ Ext. ] for the connection \* of an additional external switch or button for the electrical appliance.

\* electrical connection, see page 25.

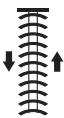

Buttons 1 and 2 are, ex works, reserved for the relay output [ L' ] and to control DuoFern Universal actuators.

If required, this factory setting can be removed, see page 29.

Controller	Design	Function		
		 T1 T3 T5	 T2 T4 T6	
	<b>Activate or deactivate the light or appliance</b>	1 x tap	ON	OFF
	<b>Control roller shutters / Venetian blinds</b>	1 x tap	UP	DOWN
		tap again	STOP	STOP
	<b>Roller shutters / Venetian blinds in jog mode</b>	1 x tap	briefly UP	briefly DOWN
		1 x long	UP	DOWN
		tap again	STOP	STOP
 100 % 0 %	<b>Dim light or save interim values</b>	1 x tap	0 to 100 %	100 % to 0
		2 x tap	go directly to 100 %	go directly to 0
		1 x tap in opposite direction	e.g. save 75 %	e.g. save 45 %
		Press and hold	0 to 100 %	100 % to 0
		release	e.g. save 75 %	e.g. save 45 %

Activate the registering mode, see page 30.



1 sec.

Activate the log-off mode, see page 32.



1 sec.

Clear the DuoFern network, see page 35.



5 sec.

Activate the jog mode, see page 36.



1 sec.

Set lighting, see page 37.



5 sec.

Activate the reversal of rotation direction mode, see page 39.



5 sec.

Software reset, see page 41.







5 sec.

**Mains supply [L/N]**

Mains supply voltage:	230 V / 50 Hz ~
Consumption:	Standby: < 0.6 W

**Connection [L' and L/N]**

Switching voltage:	230 V / 50 Hz ~	
Maximum switching capacity:	ohmic load, e.g. bulbs	
		12 A (μ) (Type 1B)
	inductive loads such as: fluorescent lamps, drives, iron core transformers, e.g. for extra-low voltage bulbs such as halogen bulbs	
		6 A (μ) (Type 1B)
		
		
capacitive loads such as: electronic transformers, AC/DC transformer, e.g. for extra-low voltage lamps such as halogen lamps, LEDs, etc.		
	6 A (μ) (Type 1B)	

**Control input [Ext.]**

for an external, manual switch / push button on site

Input voltage:	230 V
Maximum length of the control cable:	10 m



**Improper use can lead to serious injuries or property damage.**

- ◆ Due to the small contact distance ( $\mu$ ), not suitable for disconnecting.
- ◆ The DuoFern Multiple Wall Controller 9494-2 should not be used for an electrically safe disconnection of the connected appliances.

**General information**

Permissible ambient temperature:	0 °C to 40 °C
Protection class:	II ( <i>only for use in dry rooms</i> )
Dimensions (W x H x D):	50 x 50 x 12 mm (operating unit)
Installation depth	32 mm (installation housing)
Connecting terminals:	Screw terminals for max. 1.5 mm <sup>2</sup> cable cross-section

**DuoFern radio technology**

Transmission frequency:	434.5 MHz
Transmission power:	max. 10 mW
Range:	indoors: approx. 30 m * outdoors: approx. 100 m * <i>depending on the building structure</i>
Max. number of DuoFern devices:	8 per button group 24 in total

**Factory settings**

DuoFern devices:	none
Jog mode:	deactivated, for all groups
Allocation of switch relay:	Buttons 1 and 2
Lighting:	Off

**6.1 Conduct in the event of a power failure****Data retention following a power failure**

All settings remain permanently saved. Data is not lost even after a longer power failure.





---

**The use of defective equipment can lead to personal injury and damage to property (electric shocks / short circuiting).**

---

- ◆ Never use defective or damaged equipment.
  - ◆ Check that the DuoFern Multiple Wall Controller is intact.
  - ◆ Consult our customer service department in the event that you discover damage, see page 48.
- 



---

**There is a risk of fatal electric shock when touching electrical components of the DuoFern Multiple Wall Controller 9494-2.**

---

- ◆ Switch off the mains power before removing the cover panel.
  - ◆ The DuoFern Multiple Wall Controller 9494-2 should not be operated without the cover panel and frame.
  - ◆ Assemble all the components of the operating unit before inserting it into the installation housing.
- 



---

**Short-circuiting, caused when the DuoFern Multiple Wall Controller 9494-2 is overloaded, poses a danger to life.**

---

- ◆ The maximum switching capacity must not be exceeded.
- ◆ Only use the control output [L'] for connecting and controlling electrical appliances (e.g. lighting etc.) within the permissible load limits, see "Technical Specifications" on page 14.

Only use the DuoFern Multiple Wall Controller to log on and control DuoFern devices.

### **Operating conditions**

---

- ◆ The associated tubular motor must be fitted with a mechanical or electronic end position switch.
- ◆ Only use the DuoFern Multiple Wall Controller 9494-2 in dry rooms.
- ◆ For the electrical connection of the DuoFern Multiple Wall Controller 9494-2, a 230 V/50 Hz power supply, together with a site-provided disconnecting device (fuse), must be available at the installation location.
- ◆ The installation and operation of the radio systems is only permitted for those systems and devices where a malfunction in the transmitter or receiver would not cause a danger to personnel or property or where this risk is already covered by other safety equipment.

Using the DuoFern Multiple Wall Controller for any other purpose than previously mentioned is not permissible.



**Improper use can lead to serious injuries or property damage.**

- ◆ Never use the radio system (e.g. DuoFern radio system) and its components for the remote control of appliances and systems with increased safety-relevant requirements or where there is an accident risk. Such applications require additional safety equipment. Observe the respective statutory regulations for the installation of such systems.
- ◆ The DuoFern Multiple Wall Controller 9494-2 should not be used for an electrically safe disconnection of the connected appliances.



**There is a risk to life caused through short circuiting and electric shocks if the DuoFern Multiple Wall Controller 9494-2 is used outside or in damp rooms.**

- ◆ Do not install and use the DuoFern Multiple Wall Controller 9494-2 outdoors or in damp rooms.

## 7.3 Required expert knowledge of the installer

The electrical connection, installation and commissioning of the DuoFern Multiple Wall Controller 9494-2 must only be carried out by a qualified electrician in accordance with the instructions in this manual.

The DuoFern Multiple Wall Controller 9494-2 is intended for flush mounting. We recommend installation in a deep 58 mm flush-mounted box or in an electronic socket.

The label insert must be printed and the electrical connection must be carried out prior to installation.

## 8.1 Printing the label insert



**There is a risk of fatal electric shock when touching electrical components of the DuoFern Multiple Wall Controller 9494-2.**

- ◆ Switch off the mains power before removing the cover panel.
- ◆ The DuoFern Multiple Wall Controller 9494-2 should not be operated without the cover panel and frame.
- ◆ Assemble all the components of the operating unit before inserting it into the installation housing.

1. The provided label insert can be printed with the application specified by you. Please only use a laser printer for printing. \*
2. Lift the transparent cover panel from the operating panel and insert the printed paper into the cover panel. Next, press the cover panel on to the operating unit until it locks in place.

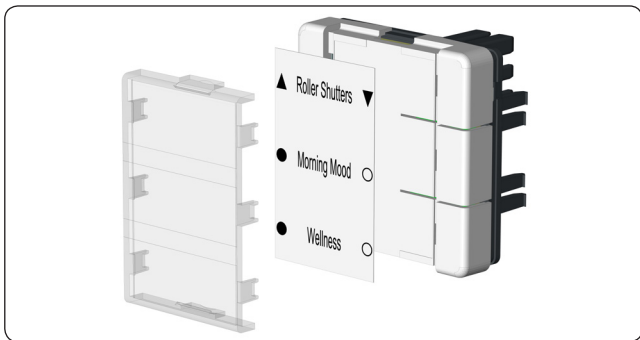

Templates can be found on our website: [here](http://www.rademacher.de), individual label inserts can be created and printed.

\* *Should you have no access to a laser printer, please alternatively use standard printing paper for the label insert.*

### Avoid installation near disturbing sources



Radio systems that transmit on the same frequency can cause interference.

- ◆ Do not install the DuoFern Multiple Wall Controller in the proximity of powerful radio systems.
- ◆ In order to ensure optimal operation, the DuoFern Multiple Wall Controller should not be installed on a metallic base or near metal objects.

## 8.3 Connecting the DuoFern Multiple Wall Controller 9494-2

Prior to the electrical connection, check that the voltage / frequency on the type plate corresponds to that of the local mains supply.



Read the specifications relating to the electrical connection detailed in the instruction manual of the electrical appliance used.

### Length of insulation stripped:

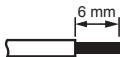

All leads must be stripped to 6 mm.

### **DANGER!**

**There is a risk of fatal electric shock when touching electrical components.**

---

- ◆ All connection and installation work must only be carried out in a de-energised state.
  - ◆ Disconnect all phases of the mains power cable and secure it to prevent any reconnection.
  - ◆ Check that the system is de-energised.
- 

### **WARNING!**

**Using an incorrect installation housing can lead to personal injury and damage to property (electric shocks / short circuiting).**

---

- ◆ Only use the installation housing provided to connect and install the DuoFern Multiple Wall Controller 9494-2.
- ◆ Installation housings of other RADEMACHER products are not compatible.

**Connection instructions when using an external switch/ push button**

---

- ◆ When using the control input **[Ext.]**, you must connect the external switches / push buttons and the DuoFern Multiple Wall Controller 9494-2 to the same phase **[L]**.
- ◆ The maximum length of lead to connect an external switch/ push button must not exceed 10 m.

- 1.** Ensure the mains is disconnected and check whether the mains power cables are current-free.
- 2.** Securely lay the connecting cables right into the flush-mounted box.
- 3.** Remove the insulation on all leads down to 6 mm in length and connect them according to the following connection diagram.
- 4.** After the electrical connection, the installation of the installation housing into the flush-mounted box and the installation of the operating unit are carried out, see page 27.



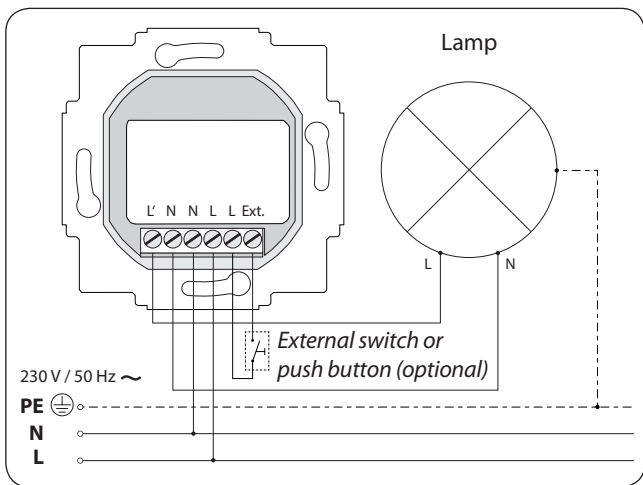

The additional connection terminals [N] and [L] are solely intended for wiring the connected electrical consumers and/or an external switch / push button.

- ◆ Do not use the connection terminals [N] and [L] for further indoor installations.

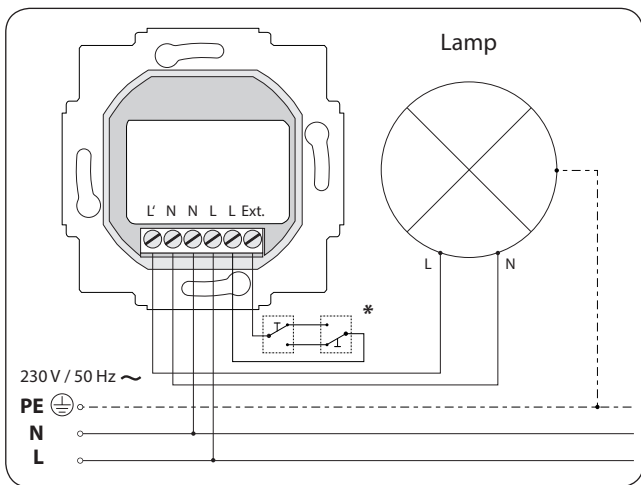

## 8.7 Connection Diagram with Changeover Switch

**EN**

\* *Changeover switch (cross connection also possible)*



The additional connection terminals [N] and [L] are solely intended for wiring the connected electrical consumers and/or an external switch / push button.

- ◆ Do not use the connection terminals [N] and [L] for further indoor installations.

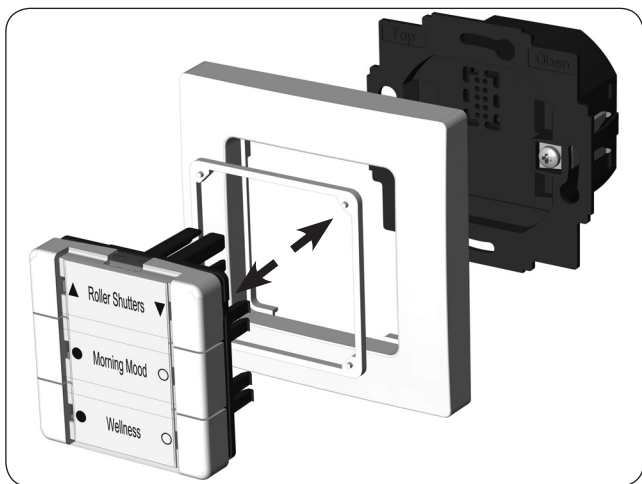

1. Insert the installation housing into the flush-mounted box and fasten it with the screws of the claw fasteners.
2. Place the frame on the installation housing and put the spacer frame into the frame.
3. Then carefully insert the operating unit into the installation housing .
4. Switch on the mains power supply again.
5. The lighting will turn on and the LEDs indicate the operational readiness by means of a running (continuous) light.

### Information for logging on DuoFern devices

---



Only DuoFern devices or devices within the same class/category can be allocated to a specific button group.

When logging on, the individual DuoFern devices are automatically detected by the DuoFern Multiple Wall Controller, and the available button groups are displayed.



Please read the instruction manual for the respective DuoFern device.



Buttons 1 and 2 are, ex works, reserved for the relay output [ L' ] and to control DuoFern Universal actuators.

If required, this factory setting can be removed, see page 29.

### Controlling the relay output [ L' ] with a DuoFern transmitter

---

If a DuoFern transmitter is logged on to the DuoFern Multiple Wall Controller 9494-2, the relay output [ L' ] can be switched with this.

### Max. number of DuoFern devices

---

You can log a maximum of 8 DuoFern devices on to each button group.



To remove the reservation, no DuoFern devices should yet be logged on to buttons 1 and 2.

Should DuoFern devices already be logged on, a software reset must be carried out first, see page 41.

### Removing the factory default reservation for buttons 1 and 2

1. Log off all DuoFern devices from buttons 1 and 2, see information above.

2.

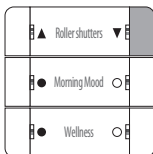

10 sec. Press and hold the button 2 for approx. 10 seconds.

LEDs 1 and 2 will light up white.



The relay output [L'] can still be operated via a DuoFern transmitter after the disconnection.

### Restoring the factory default reservation for buttons 1 and 2

1. Repeat steps 1 and 2 above.

The LEDs 1 and 2 will light up red as soon as the reservation of the buttons is restored.

1. Switch the desired DuoFern device to the registering mode (please refer to the relevant instruction manual).

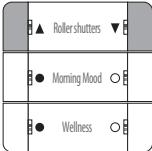
2.  1 sec. Activate the registering mode of the DuoFern Multiple Wall Controller. Simultaneously press and hold the buttons 1 and 2 for 1 second. LEDs 1 and 2 will flash white.

 120 sec.

The registering mode remains active for approx. 120 seconds.

3. After successfully logging on, the LEDs of the remaining available buttons will light up white.
4. Tap on the desired available button group to allocate the new DuoFern device to this button group. You can use the left or right button. The successful assignment is confirmed by the white LEDs flashing three times briefly.

### Notes on multi-channel actuators

The first channel is initially assigned with multi-channel actuators and then confirmed by the white LEDs flashing three times briefly. The LEDs that are still free then light up white again.

The next channel can now be assigned by tapping the desired free button group.

**If you want to skip a channel when logging on, proceed as follows as soon as the free LEDs light up white:**

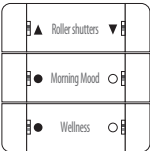
5.  5 sec. Press any button and hold for 5 seconds.

- 
6. Once the channel has been successfully skipped, all LEDs will briefly flash red.
- 
7. You can then assign the next channel if the actuator has more channels available.
- 
8. Log-on the next DuoFern device.

### Pay attention to the LEDs

---

All LEDs will light up red, one after the other, if the log-on was unsuccessful. For example, if...

- ◆ 8 DuoFern devices are already logged on to a button group.
- ◆ an unsuitable device is logged on.

1. Switch the desired DuoFern device to the log-off mode (please refer to the relevant instruction manual).

2.

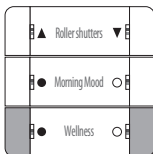

Activate the log-off mode on the DuoFern Multiple Wall Controller. Simultaneously press and hold the buttons 5 and 6 for 1 second.

LEDs 5 and 6 will flash red.

The log-off mode remains active for approx. 120 seconds.

1 sec.

⌚ 120 sec.

3. After successfully logging off, the LED of the relevant button will light up white.



In combination with the HomePilot®, all 6 buttons of the DuoFern Multiple Wall Controller can be used to individually trigger scenes. To do so, it must first be logged on to the HomePilot®.

1. Open the user interface of the HomePilot® and click left on the button [**configuration**] and then on [**register device**].

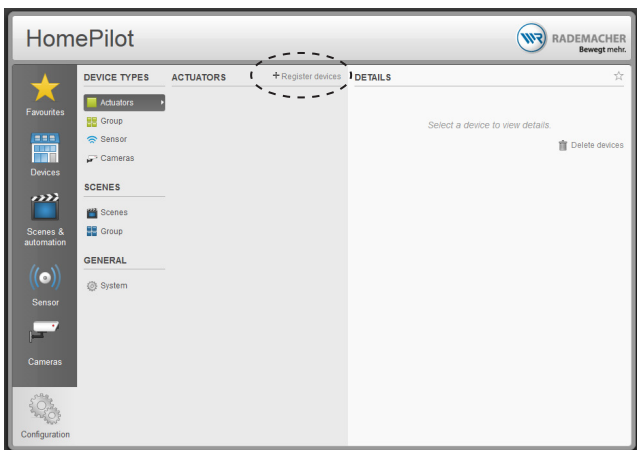

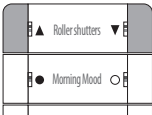

2.  1 sec. Simultaneously press and hold the buttons 1 and 2 for 1 second to activate the registering mode of the DuoFern Multiple Wall Controller.

3. Two devices are displayed in the left table after successfully logging on:
- ◆ a transmitter DuoFern Multiple Wall Controller
  - ◆ an actuator DuoFern Multiple Wall Controller

Register devices...

**NEW DEVICES**

 Actuator DuoFern Multiple Wall Controller

 Transmitter DuoFern Multiple Wall Controller

Please enter a name and description for the device **Actuator DuoFern Multiple Wall Controller**.

Click "Locate"  in order to find the device again, if necessary. Close the configuration screen for this device with "Save".

Surname

Description

Symbol 

4. Click on the desired device and assign an individual name, if required. In addition, a graphic symbol can be selected.
5. Save the setting. The DuoFern Multiple Wall Controller is then listed on the left under "devices" and "transmitters" and can be used immediately.

This function enables you to log off all DuoFern devices from the DuoFern Multiple Wall Controller that are no longer accessible via radio.



Not all battery-operated DuoFern devices can be logged off in this way.

A software reset must be carried out in order to logout and delete all DuoFern devices, see page 41.

1.

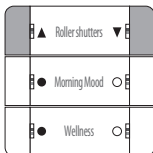

5 sec. Activate the clear up.

Simultaneously press and hold the buttons 1 and 2 for 5 seconds.

During the clear up period, LEDs 1 + 2 will flash red.

2. Once the clear up process has been successfully completed, LEDs 1 + 2 will briefly light up white.

### Cancelling the clear up function

You can cancel the clearing process at any time by briefly pressing any random button.

In the jog mode, the DuoFern Multiple Wall Controller can be used, e.g. to control Venetian blinds.

 5 sec.

Attention! The switching mode only remains active for approx. 5 seconds.

### Activate the jog mode for one button group

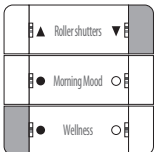
- 

1 sec. Activate the switching mode.  
Simultaneously press and hold the buttons 2 and 5 for 1 second.  
LEDs 2 and 5 will flash red.

- If there is a switching mode for one of the button groups, the according LEDs 1 to 6 will light up white.

left LED white

jog mode is deactivated

right LED white

jog mode is activated

### **Tilting the slats**

---

Briefly tapping the operating buttons enables Venetian blinds slats to be conveniently configured.

### **Driving the slats into the end position**

---

Press the operating button longer to drive the Venetian blinds into the end position. The drive can be stopped again by briefly tapping the button again, see page 12 "Button functions".

The DuoFern Multiple Wall Controller 9494-2 has permanent lighting that has four different settings (Off + 3 levels of brightness).

### Function when on standby

The lighting will shine permanently in the set brightness level.

⌚ 5 sec.

Attention! The setting mode only remains active for approx. 5 seconds.

1.

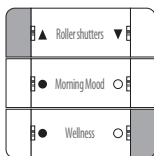

1 sec. Activate the setting mode.  
Simultaneously press and hold the buttons 1 and 6 for 1 second.  
LEDs 1 and 6 will flash red.

2. Set the brightness level for the standby mode.

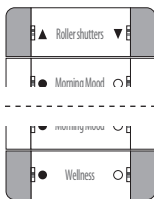

Brighter

Darker

This function can be used to change the direction of rotation of a connected DuoFern component (e.g. a radio tubular motor) as required.



To use this function, only one component may be logged on per button group.

If several devices are already logged on, log on the DuoFern component for which you want to change the direction of rotation to one of the free button groups.

- ⌚ 5 sec. Attention! The reversal of rotation direction mode only remains active for approx. 5 seconds.

### Activating the reversal of rotation direction mode

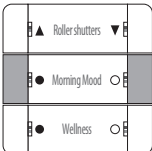
- 

1 sec. Simultaneously press and hold buttons 3 and 4.  
LEDs 3 and 4 will flash red.

- If there is a reversal of rotation direction mode for one of the button groups, the associated LEDs 2, 4 and 6 will light up white.
- Press any button in the indicated button group to reverse the rotation direction.
- LEDs 1, 3 and 5 will briefly light up red and turn white once the direction of rotation has successfully been reversed.

## **i** 13. Carrying out a hardware reset, e.g. if a unit fails **EN**

We recommend resetting the hardware if the DuoFern Multiple Wall Controller 9494-2 fails.



All settings remain unaltered when the hardware is reset.

- 1.** Carefully pull the operating unit out of the installation housing.
- 2.** Wait approx. 5 seconds and then carefully reinsert the operating unit into the installation housing.
- 3.** Subsequently check that the DuoFern Multiple Wall Controller 9494-2 is functioning correctly.
- 4.** If the DuoFern Multiple Wall Controller 9494-2 is still not reacting, carry out a software reset (see page 41) and test the DuoFern Multiple Wall Controller 9494-2 with the factory settings.



A software reset must be carried out to reset the DuoFern Multiple Wall Controller to the original default condition as when supplied.

1.

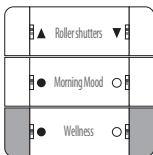

Press and hold buttons 5 and 6 simultaneously until all LEDs continuously light up red.

2. All settings have been erased and reset to the default factory settings. All of the registered DuoFern devices are automatically logged-off.



**There is a risk of fatal electric shock when touching electrical components.**

- ◆ Disconnect all phases of the mains power cable and secure it to prevent any reconnection. Check that the system is de-energised.
1. Carry out a software reset (see page 41) to log off all DuoFern devices from the DuoFern Multiple Wall Controller.
  2. Ensure the mains are current-free. Secure it from restarting and check that the system is de-energised.
  3. Carefully pull the operating unit and then the frame out of the installation housing.
  4. Release the claw fasteners of the installation housing and pull it out of the flush-mounted box.
  5. Disconnect the connecting cable from the installation housing.
  6. Secure the connection point against restarting and the connecting cable from unintentional contact.

**CE** RADEMACHER Geräte-Elektronik GmbH hereby declares that the DuoFern Multiple Wall Controller 9494-2 complies with the Directive **2014/53/EU (Radio Equipment Directive)**.

The full text of the declaration of conformity is available at the following website:

[www.rademacher.de/ce](http://www.rademacher.de/ce)

RADEMACHER Geräte-Elektronik GmbH shall provide a 24-month warranty for new systems that have been installed in compliance with the installation instructions. All construction faults, material defects and manufacturing defects shall be covered by the warranty.

Your statutory warranty claims shall remain unaffected by this warranty.

**The following shall not be covered by the warranty:**

- ◆ Incorrect fitting or installation
- ◆ Non-observance of the installation and operating instructions
- ◆ Improper operation or wear and tear
- ◆ External influences, such as impacts, knocks or weathering
- ◆ Repairs and modifications by third parties, unauthorised persons
- ◆ Use of unsuitable accessories
- ◆ Damage caused by unacceptable excess voltages (e.g. lightning)
- ◆ Operational malfunctions caused by radio frequency overlapping and other such radio interference

A prerequisite for the warranty is that the new device must have been purchased from one of our approved specialist retailers. Proof of this must be provided by presenting a copy of the bill.

RADEMACHER shall remedy any defects that occur within the warranty period free of charge either by repair or replacement of the affected parts or by supplying a new replacement unit or one to the same value. There shall be no general extension of the original warranty period by delivery of a replacement or by repair as per the terms of the warranty.



## 18. Cut out label insert

EN

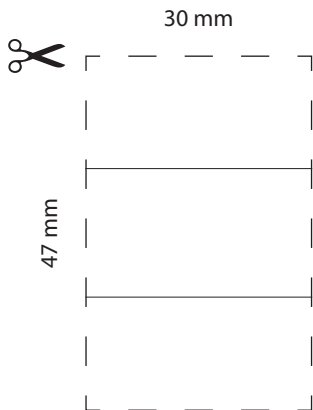





**RADEMACHER**

Geräte-Elektronik GmbH  
Buschkamp 7  
46414 Rhede (Germany)  
info@rademacher.de  
www.rademacher.de

**Service:**

Hotline 01807 933-171\*  
Fax +49 2872 933-253  
service@rademacher.de

- \* 30 seconds free of charge, subsequently 14 cents / minute from German fixed line networks and max. 42 cents / minute from German cellular networks.